

CONOTEC

CONOTEC CO., LTD.
DIGITAL TEMPERATURE CONTROLLER



INVENTION PATENT NO. 0441398
DESIGN REGISTRATION NO. 0316273
UTILITY MODEL NO. 0301508

FOX-301SERIES

Instruction Manual



- A user manual for this product is posted on the company website.
- Please download the technical document and communications manual on the company website

01 Safety precautions

Please read the safety precautions carefully for correct operation of the product.

- ✱ The specifications and dimensions specified in this instruction manual may be changed without any notice for performance enhancement.

▲ Warning

1. This product was not made as a safe device. Therefore, this product should be attached with dual safety devices if it is used for the control purposes (e.g. a device vulnerable to accident and property damage, etc.).
2. Do not wire, inspect or service this product while the power is being supplied.
3. You must attach this product to a panel. Otherwise, it may cause an electric shock.
4. When connecting the power, you must check the terminal number.
5. Do not ever disassemble, process, modify or repair this product.

▲ Caution

1. Please make yourself familiar with all the operation instructions, safety precautions and warnings before using this product. Comply with related specifications and capacity requirements
2. Do not wire or install this product to any unit with high inductive load (e.g. motor, solenoid, etc.).
3. Use a shielded cable with a proper length when extending a sensor.
4. Do not use any part that generates an arc when used in the same power or directly switched in close proximity.
5. Keep the power cable away from a high-voltage cable and do not install this product in any place that is full of water, oil and dust.
6. Do not install this product in any place that is exposed to direct sunlight or rain.
7. Do not install this product in any place that is subject to strong magnetic power, noise, vibration or shock.

8. Keep this product away from any place that generates strong alkaline or acid substances. Use a separate pipe.
9. Do not sprinkle water onto this product for cleaning when installing it in the kitchen.
10. Do not install this product in any place where the temperature/humidity ratings are exceeded
11. The sensor cable should not be cut or cracked..
12. Keep the sensor cable away from a signal cable, a power cable or a load cable. Use a separate pipe.
13. Keep in mind that the follow-up service will not be available if this product has been arbitrarily disassembled and modified
14. ⚠ symbol on the terminal wiring diagram indicates a safety statement that alerts a warning or caution.
15. Do not use this product near any device generating strong high-frequency noise (e.g. high-frequency welding machine, high-frequency sewing machine, high-frequency radio, large-capacity SCR controller, etc.).
16. Using this product in any method other than those specified by the manufacturer may lead an injury or a property damage
17. The product is not a toy. Keep it away from children.
18. The product should be installed only by an expert or a qualified person.
19. The company will not be liable for any damage caused by the violation of the above warnings and cautions or by a consumer's fault

▲ Danger

Caution: Risk of electric shock

- Electric shock – Do not touch the AC terminal while the current is flowing. It may cause an electric shock.
- Please intercept input power surely when input power check

02 Model Types

Model	Sensor	Range	Dimension	Function
FOX-301AR1	HCPV-220NH	-40.0 ~ 65.0°C 10 ~ 95%	W72 x H72mm	Temp./Humi. control RS485
FOX-301JR1			W193.5 x H241mm	
FOX-8301R1			W94 x H150mm	
FOX-301JSH	SHT11	0.0%~100.0%Rh	W194 x H241mm	Temp./Humi. control

03 Components

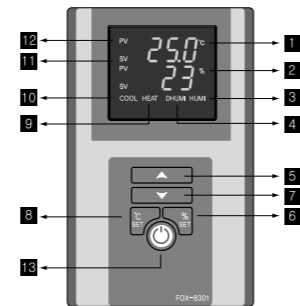

- 1 Temp. measured value display (red)
- 2 Humi. measured value display (green)
- 3 Humi. output display
- 4 Dehumi. output display
- 5 Set value(UP) key
- 6 Humi. mode changing key
- 7 Set value(DOWN) key
- 8 Temp. mode changing key
- 9 Heating output display
- 10 Cooling output display
- 11 Set value display
- 12 Measured value display
- 13 Power

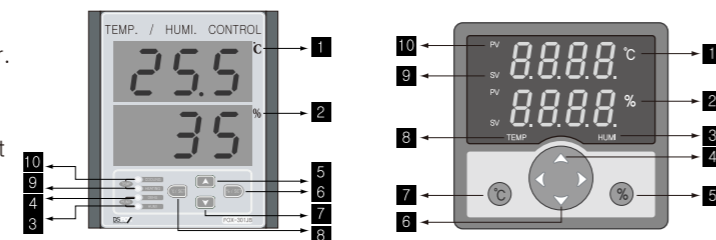

04 Terminal wiring diagram

[FOX-301AR1]

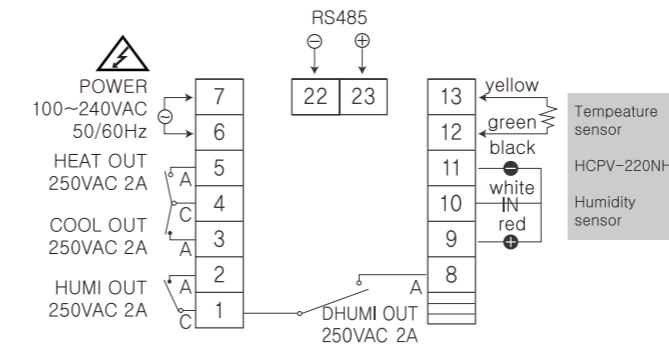

[FOX-301JR1]

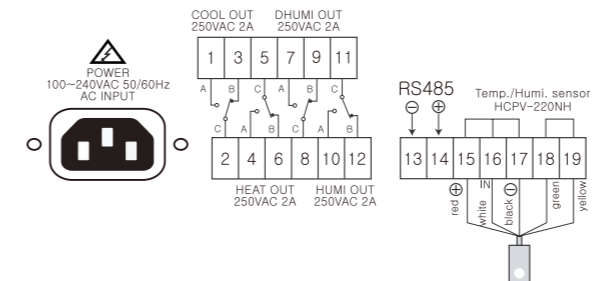

[FOX-301JSH]

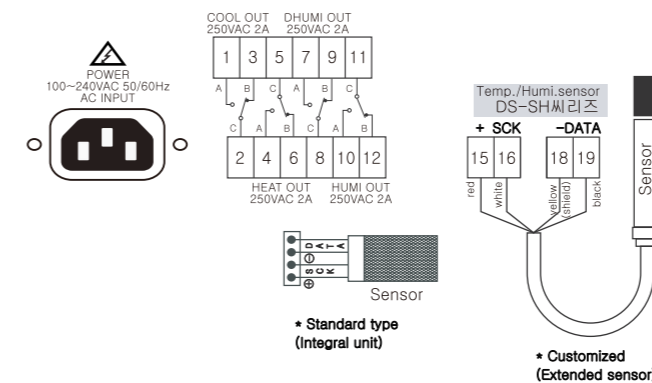

[FOX-8300R1]

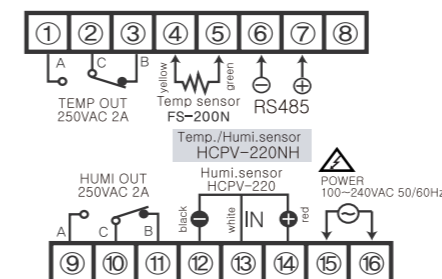

05 Dimension and panel hole sizes

(Unit : mm / error : ±0.5)

▶ FOX-300AR1, FOX-300-2S1(72x72x110mm)

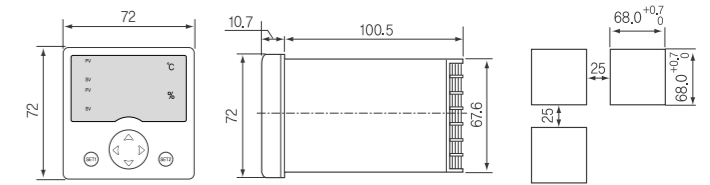

▶ FOX-300JR1(194x241x60mm)

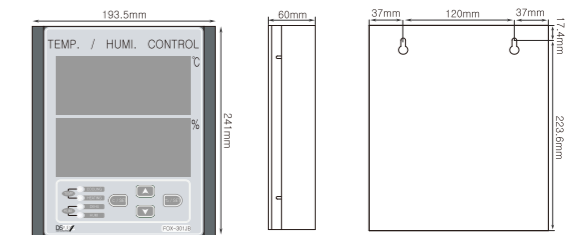

▶ FOX-8300R1(94x150x39mm)

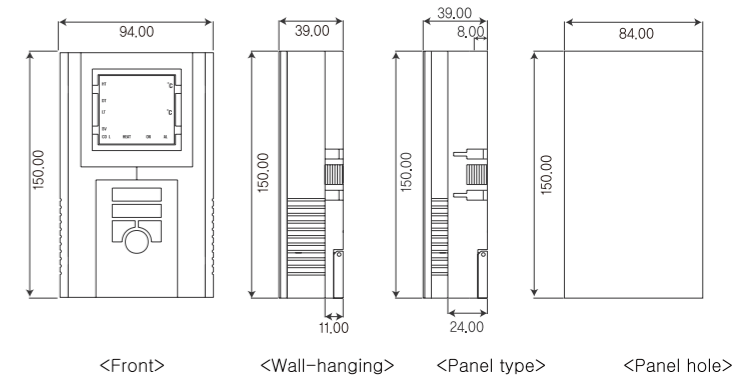

<Front>

<Wall-hanging>

<Panel type>

<Panel hole>

06 Terminal wiring diagram

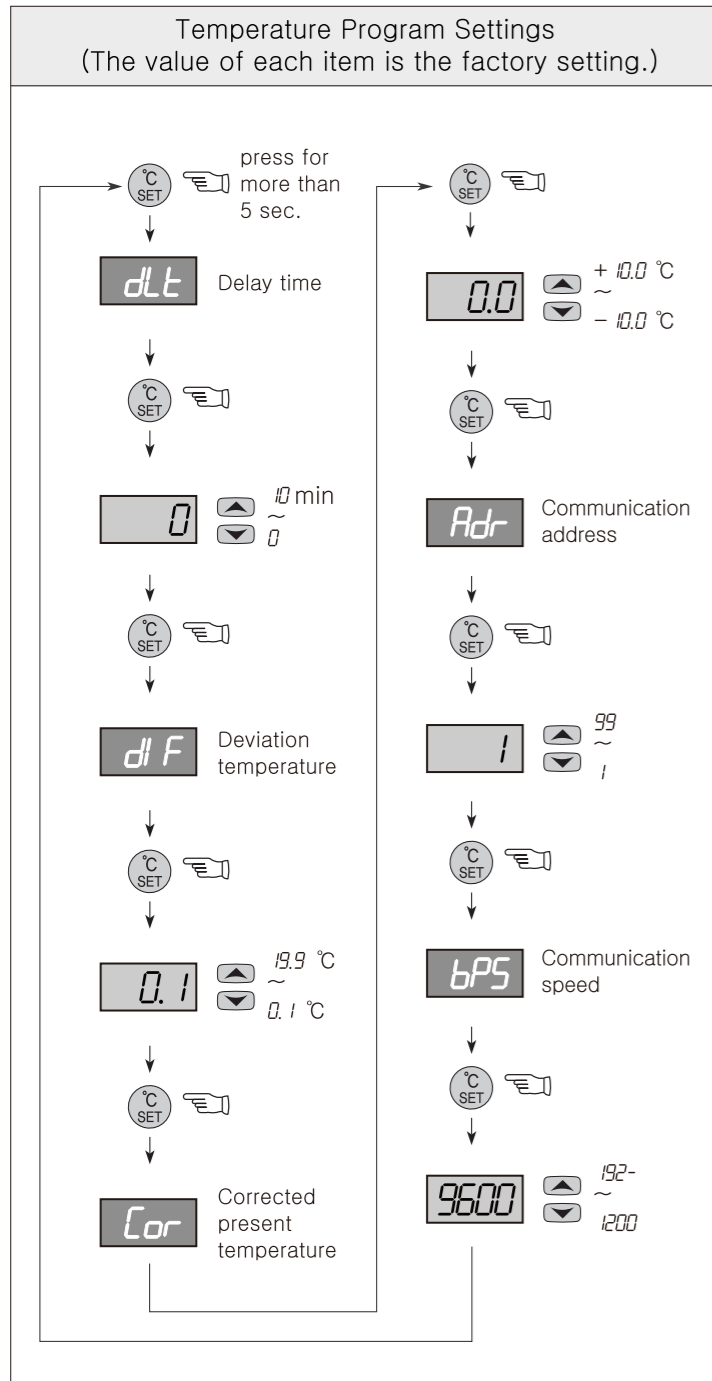
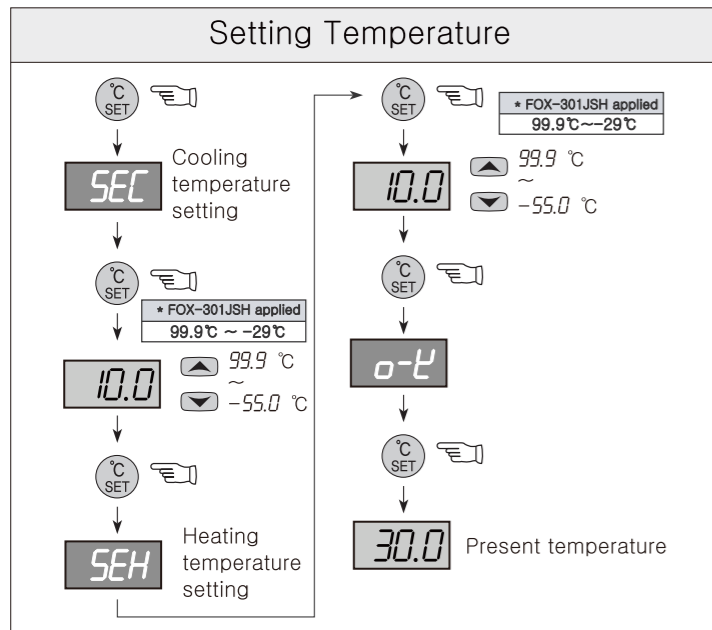

07 Terminal wiring diagram

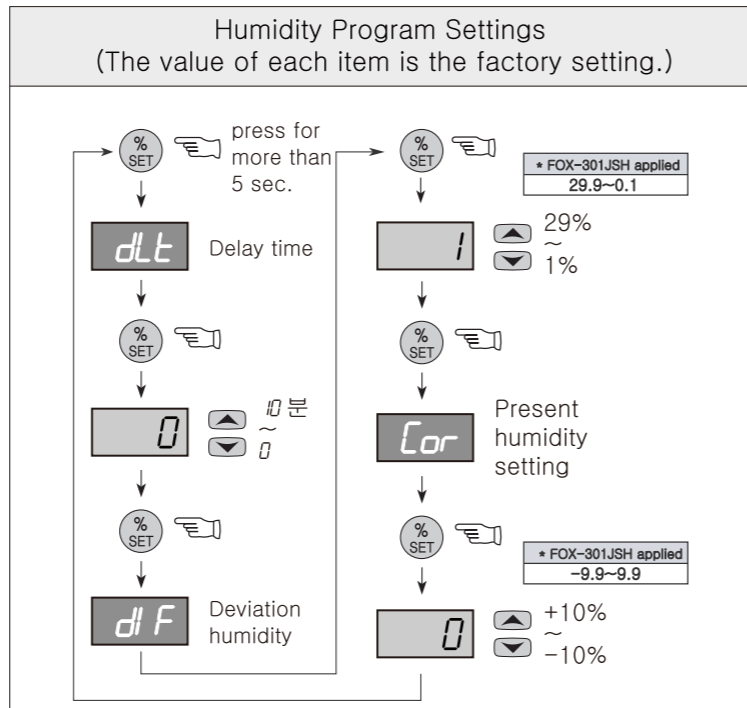
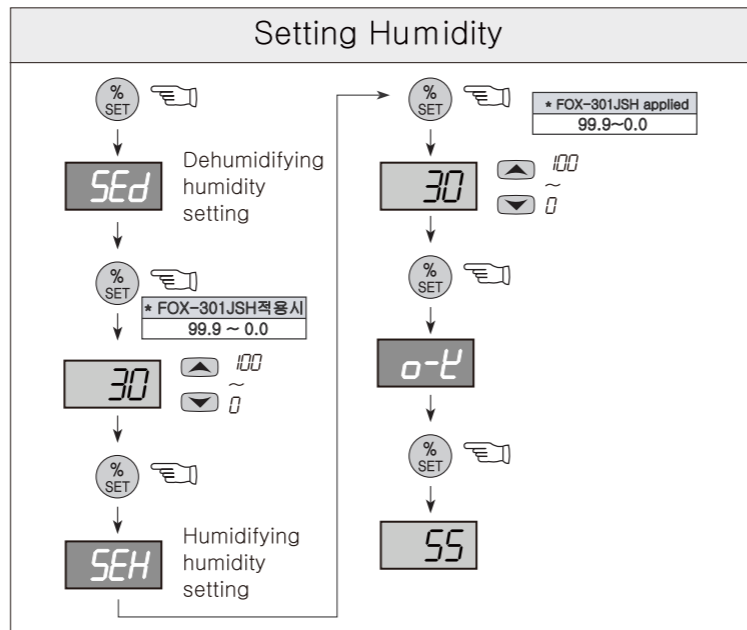

※ Pressing SET key for 5 sec. in the state of current temperature display can be entered the program setting mode.
 ※ All programs are returned automatically in 30 sec. to the present temperature after displaying o-k by pressing SET key once after set value changing.

08 Function details

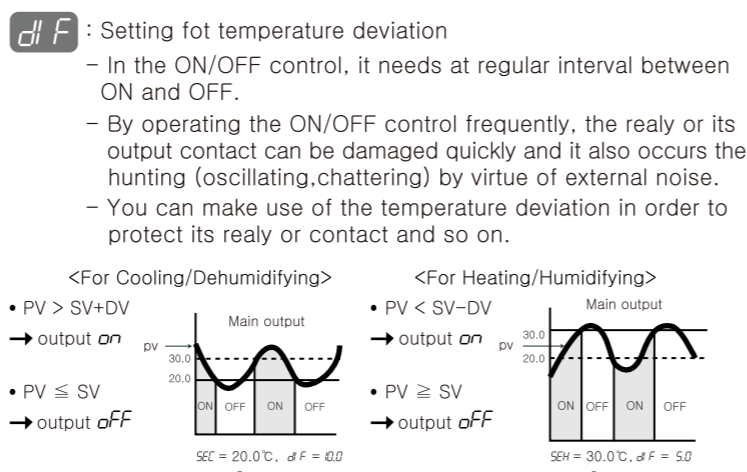

dLt : Output Delay Time

- It is widely used as the followings in case of operating the ON/OFF control very often, (Cooler, Compressor and so on)
- To protect the operation machinery when re-input of the power supply or momentary stoppage of power supply.

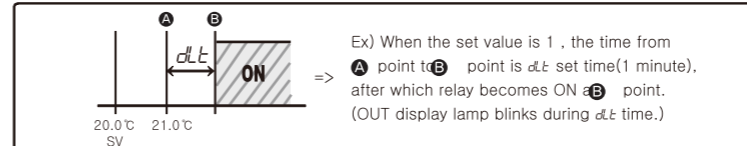

Cor : Current temperature calibration function

- While there is no problem in the product, a function to calibrate when temperature is different error and reference standard that occur in the input sensor (e.g. Mercury thermometer or thermomete currently use, a temperature controller)
- Ex) Actual temperature : 10.0°C → Modification of 0.0 to -2.0
 Display window : 12.0°C → Displayed as 10.0 (corrected current temperature)

Adr : Communication station settings.

- When using the RS485 communication, specify a station number between 1~99

bPS : Communication speed settings.

- 120 1200 : 1200BPS, 240 2400 : 2400BPS
- 480 4800 : 4800BPS, 960 9600 : 9600BPS
- 192 1920 : 19200BPS, Start Bit1, Stop Bit1, Non parity)

09 Communication interface

Applicable specification	EIA RS485
Communications method	2-line half-duplex:Asynchronous
Synchronization method	Asynchronous system
Data speed	1200/2400/4800/9600/19200bps(5 options)
Communications range	Within 1.2Km
Communications protocol	BCC
Start Bit, Stop Bit	1Bit (fixed)
Parity Bit, Data Bit	Parity Bit : None, Data Bit : 8Bit (fixed)

System Configuration

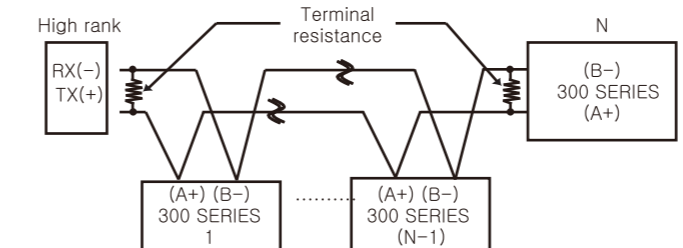

Definition of Communication Command and Block

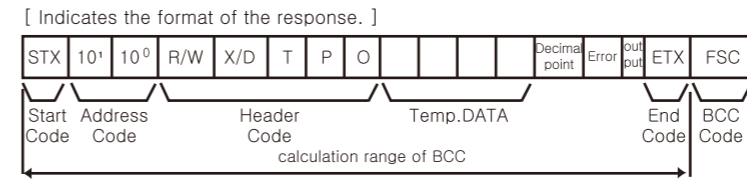
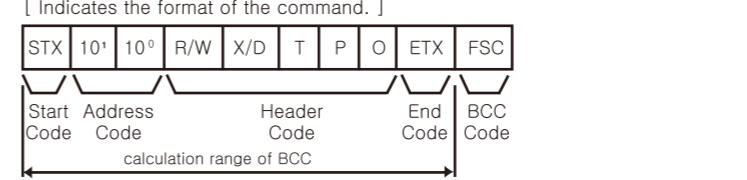

- START CODE
Displays the head of BLOCK.
STX→[02H], ACK will be added in case of Response
- ADDRESS CODE
A code of which the host system identifies FOX-301 series, and can be set from 01 to 99 (BCD ASCII)

- HEADER CODE: Indicates the name of the COMMAND in letters.
 RX (Read demand) →R[52H],X[58H]
 RD (Read response) →R[52H],D[44H]
 WX (Write demand) →W[57H],X[58H]
 WD (Write response) →W[57H],D[44H]
 TPO(Temp.measured value) →T[54H],P[50H],O[30H]
 HPO(Humi.measured value) →T[54H],P[50H],O[30H]

- DATA Configuration: DATA is expressed in Hexadecimal.
- Decimal point: 0 [30H]:No decimal point// 1[31H]:There is a decimal point
- Error: 0 [30H]:NO error// 1[31H]:Sensor open error// 2[32H]:Sensor short error

⑦ Output:

	TEMP		HUMI	
	COOL	HEAT	HUMI	DHUMI
0(30H)	O	O	0(30H)	O
1(31H)	O	X	1(31H)	X
2(32H)	X	O	2(32H)	O
3(33H)	X	X	3(33H)	X

- END CODE: Displays termination of Block. ETX→[03H]
- BCC: Block Check Character. it shows the XOR operation value from the beginning (STX) protocol to ETX.

- ※ Others
- If there is no ACK response
 - ① If code numbers are inconsistent after receiving STX
 - ② If Receive Buffer Overflow occur
 - ③ If borate or other communication SV is inconsistent
 - Handling when there is no ACK response.
 - ① Check the status of line
 - ② Check communication abnormality caused by noise, perform communication for 3 times for recovery.
 - ③ In the case of communication speed if communication abnormality is too frequent.
 - ④ Change the communication speed if communication abnormality is too frequent.

10 Easy error diagnosis instructions

- ※ If an error is displayed while the product is running
- **Er-1** : It is case where the product was subject to a strong external noise and internal data memories have been damaged. In this case, contact us for product service.
- Although this controller was designed to withstand a certain level of external noise, it is not supposed to withstand all levels of noise.
- If the product is subject to a noise greater than 2KV, it could be internally damaged.
- If **o-E** (open error) or **s-E** (short error) is displayed, there is something wrong with a sensor. Please check the sensor.

※ The above specifications may be changed without any notice for performance enhancement. Please make yourself fully familiar with and follow the above precautions.

■ Warranty period: One year from the date of purchase
 ■ Address : (Street address) 56, Ballyongsandan 1-rp, Jangan-eup, Gijang-gun, Busan, ROK
 (Land-lot address) 901-1, Ballyong-ri, Jangan-eup, Gijang-gun, Busan, ROK (46034)

- Product service : 070-7815-8289
- Customer service : 051-819-0425 ~ 0427
- FAX : 051-819-4562
- Email : conotec@conotec.co.kr
- SNS : Facebook, Instagram, Twitter, YouTube ▶ 'Search for 'Conotec'
- Website : www.conotec.co.kr

- Major products and development
- Temperature/humidity controller
 - Counter and timer controller
 - Current and voltage panel meter
 - Temperature/humidity indicator
 - Oven controller
 - CO2 controller
 - Unit cooler controller
 - Heat pump controller
 - Chiller controller
 - Thermo-hygrostat controller
 - Short message alarm
 - Temperature/humidity transmitter
 - Smartphone app and monitoring system

※ This manual was prepared in the Naver Nanum fonts.