

## Heat Pump Controller

# i 200



Thank you for using our CONOTEC's products.  
Please, be sure to read "Handling Precautions" before use, and use this product correctly.

After reading this user manual, keep it in a place where you can see at any time.  
It will be much more convenient when you use this product after reading this user manual.

Manual Version: V1.0

※ CONOTEC's services are also the best.

Through our dealer where you purchased this product, you can report on the failure or discomfort in use.

※ To improve the performance of the products, the specifications of this product are subject to change without prior notice.

Please well understand the specified contents in the precaution interval when handling this product, and be sure to comply with them.

※ This instrument is suitable for the following environments:

Ambient Temperature: 0°C~60°C

Ambient Humidity: Less than 80% RH

Rated Power: 100VAC~240VAC ± 10% 50/60Hz

■ Major Products and Developments

-Digital Temperature/Humidity Controller

-Digital Timer, Current/Voltage Meter

-Other Product Developments

# Contents

1. Handling Precautions .....	3
2. Components .....	5
3. Appearance and panel hole dimension .....	6
4. Terminal wiring and spec. ....	7
5. Special Feature .....	8
6. Switch and Display .....	9
7. Menu Road Map .....	10
8. Program menu setting .....	14
9. System information .....	24
10. Modbus-RTU .....	26
11. Error .....	34
12. Quality Warranty .....	35

# 1 Handling Precautions

Thank you for purchasing our CONOTEC's products.  
In order to use this product, please be aware of the details below.

## Safety Precautions

### Warnings

1. This product has not been manufactured as a safety device; therefore, in the case that this product is going to be used for controls, such as devices from which you feel concerned about personal injury, serious damage to the peripheral devices and enormous property damage, please use it with double safety devices attached.
2. Please do not connect, inspect or repair it when power is on.
3. The panel must be attached to use. It can be the cause of electric shock.
4. When connecting power, please be sure to identify the terminal number and connect them.
5. Please never disassemble, process, improve or repair this device.

### Caution

1. Prior to installation of this instrument, please well understand the safety regulations, warnings and how to use and use this device only within its specified relevant specifications or capacity.
2. Do not install or wire it on the motors and solenoids, etc. which are extremely inductive loaded
3. When extending sensors, please use the same lines and do not make them longer than necessary.
4. Do not use any parts which cause arc when directly opened or closed at the same power or its nearby.
5. Please keep the power line away from the high-tension power cable, and do not install it in a place where water, oil or dust is severe.
6. Please do not install it in the place of being exposed to direct sunlight or rain.
7. Please do not install it in the place of strong magnetism, noise, severe vibration and shock.
8. Please keep it away from the place where strong alkaline and strong acidic materials directly come out.
9. Do not spray water directly onto the device for the purpose of cleaning during the installation in the kitchen
10. Do not install it in a location where the temperature /humidity exceed the rated ones.
11. Please use it with the sensor wire not being broken or scratched.
12. Use an independent pipe and keep the sensor wire away from the signal line, power and load wires
13. Please note that the follow-up services are not available when arbitrarily disassembling or modifying this product.
14. A display on the terminal connection diagram is a safety phrase of caution or warning.

15. Do not use near devices causing strong high-frequency noise (high-frequency welders, high-frequency sewing machines, high-frequency radios, large SCR controller).
16. When using methods other than specified by the manufacturer, injury or property damage may occur.
17. Please keep out of children's reach, since it is not a toy.
18. Please install it by the related professional or qualified person.
19. When wiring the product, terminals and screws should be tightened with sufficient torque. Contact failure may cause a fire.
20. Do not use a load that surpassed the rated value of switching capacity of relay contact point. This may cause insulation failure, contact weld, and poor contact.
21. We disclaim all the responsibility for damages caused by the negligence of the consumer or by not complying with a warning or caution statements specified above.

 **Danger**

 **Caution, danger of electric shock**

1. Electric shock – Please do not touch the AC terminals while the power is on. You may get an electric shock.
2. When checking the input power, please be sure to shut off the input power.

## 2

## Components

### Product



### Bracket

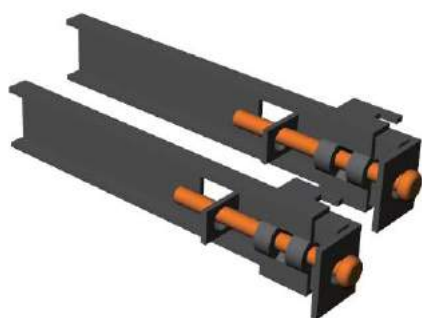

### Sensor (2ea)



### 3 Product appearance and panel dimension

Unit : mm /Error :  $\pm 0.5$

#### Product dimension

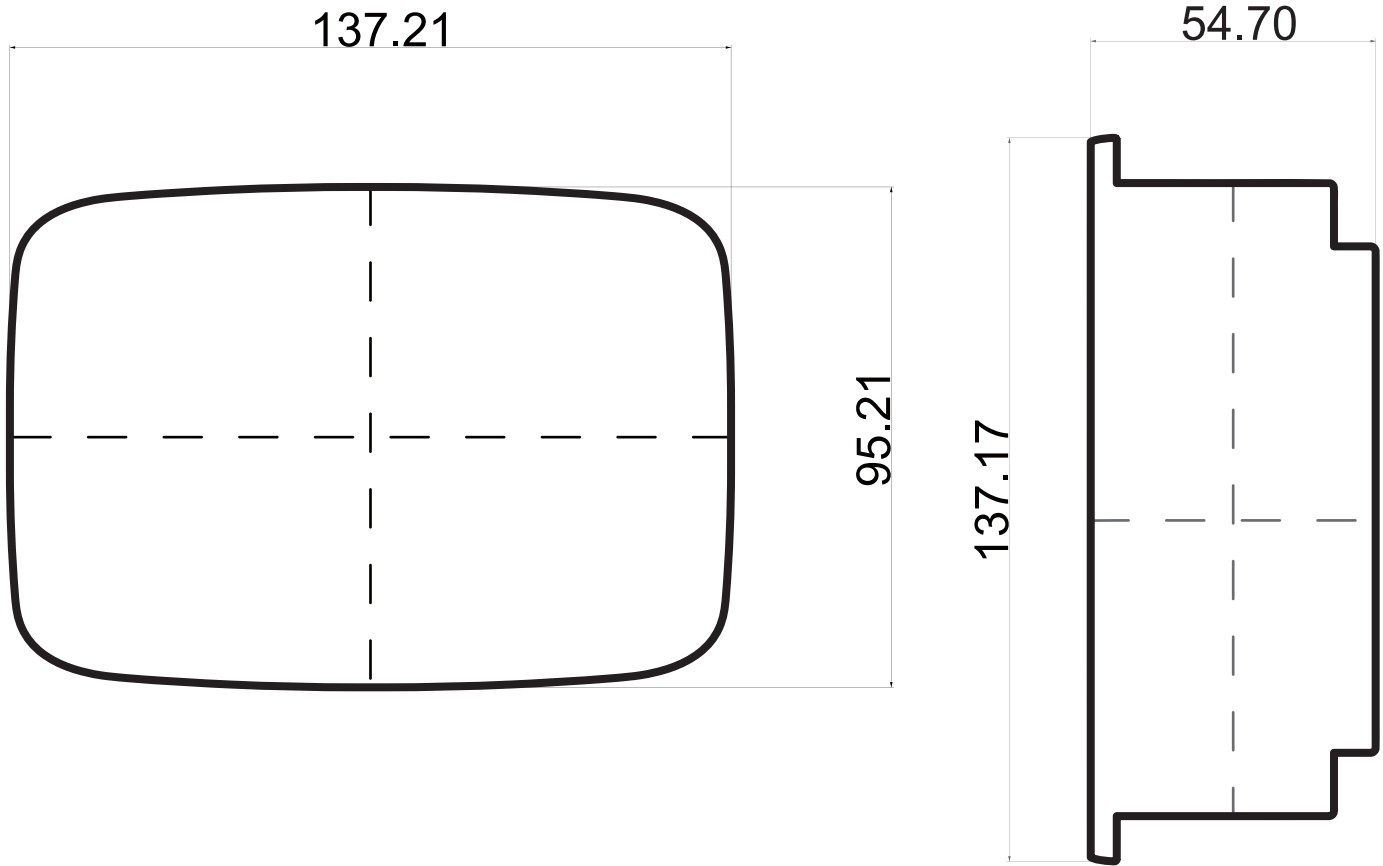

#### Panel processing dimension

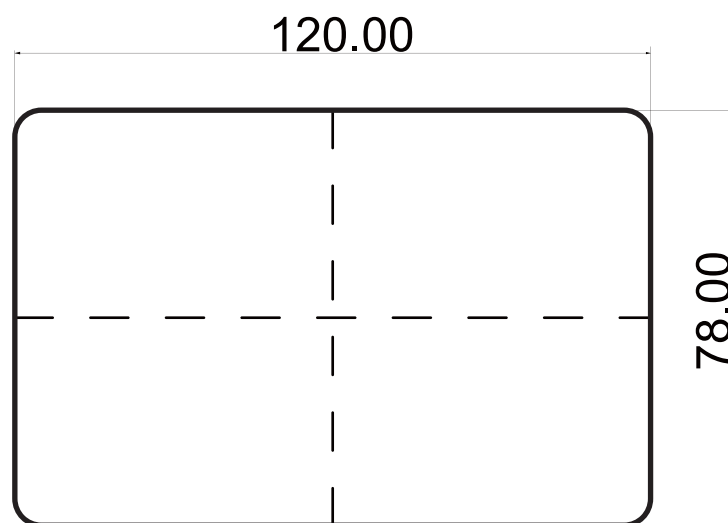

## 4 Terminal wiring methods and input/out specifications

- 1) Input Voltage : 100 ~ 240VAC
- 2) Output Voltage: The same as input voltage
- 3) Output contact capacity: Relay contact output (5A 250VAC)
- 4) Input Port: 3 Ports no power contact
- 5) Output Port : 7PORT
- 6) Sensor : 2PORT(NTC 10K $\Omega$ )
- 7) Temperature Range : -55 0. $^{\circ}$ C ~ 99 9. $^{\circ}$ C

Input Port	Port
IN1 ⑪	LP
IN2 ⑫	HP
IN3 ⑬	OP
COM ⑭	COM

Sensor	Port
SEN ⑮⑯	Indoor
SEN ⑰⑱	Defrosting

Output	Port
OUT1 ③	Defrost
OUT2 ④	Aux.Heater
OUT3 ⑤	FAN
OUT4 ⑥	COMP2
OUT5 ⑦	COMP1
OUT6 ⑧	4WAY
OUT7 ⑨	SV
COM ⑩	COM

Comm.	Port
485 ⑲⑳	Comm.

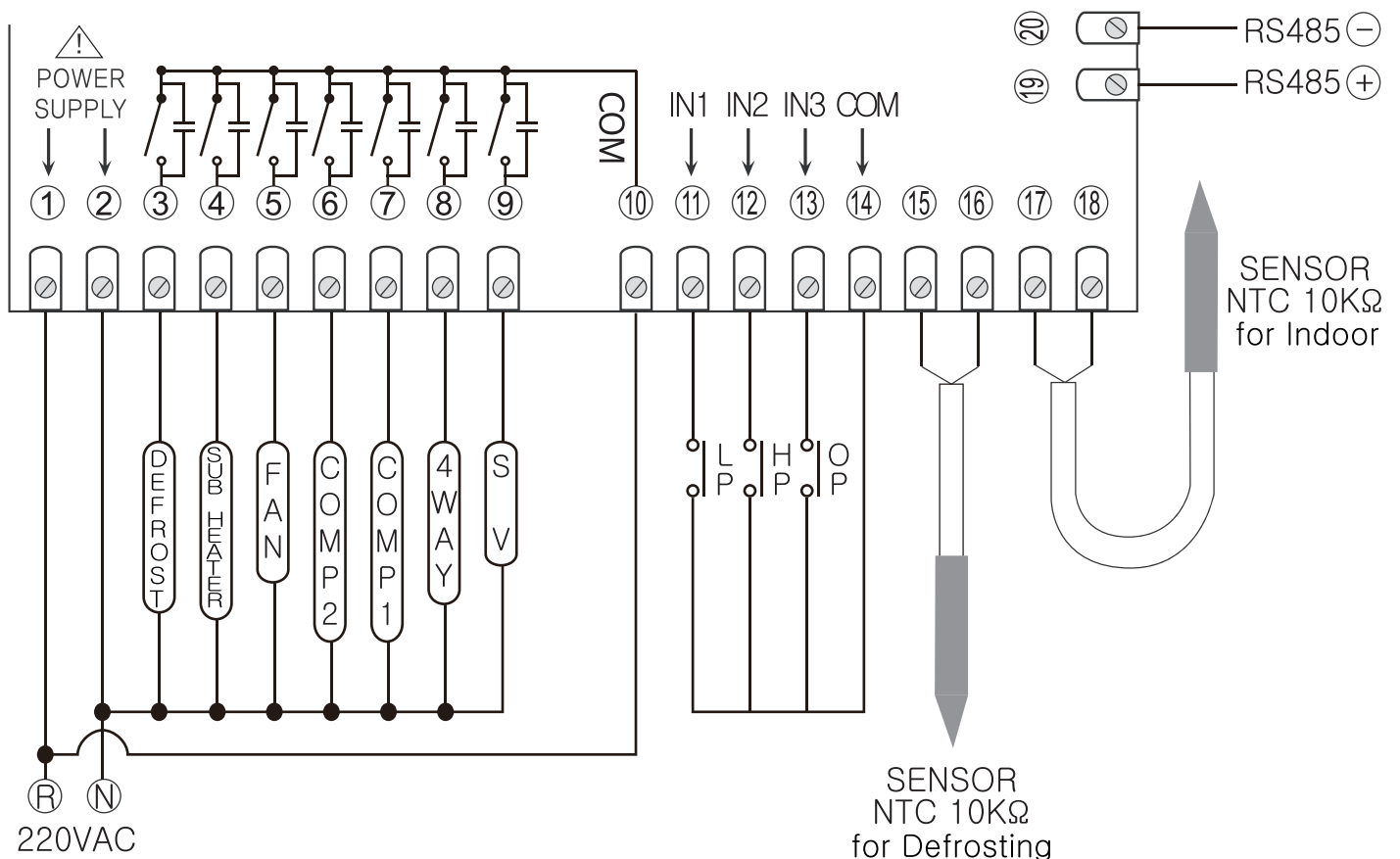



## 5 Special Feature

### (1) TFT-LCD and Touch Function

With TFT-LCD and touch, much information and colors can be displayed and easy operation and recognition support a user-oriented interface.

※ The product uses a capacitive touch method and thus requires precautions as the key may cause malfunction if touched with wet hands or used with thick gloves.

### (2) Central Monitoring Control Function

The product is embedded with the RS485 communication function to be connected to a computer. It uses the Modbus protocol to be used with the MMI (Man Machine Interface) system.

### (3) Alarm history store

Up to 20 alarm histories can be stored, which helps to analyze the cause of problems and maintenance.

### (4) Compact and Slim

The integrated display and control ensure sufficient space.

### (5) Scheduled operation

The function to operate and stop the equipment on the day and time as desired, which can help save electricity.

### (6) Various defrosting function

Periodic defrosting and temperature defrosting, a comp cumulative defrosting is added to provide a more effective defrosting.

## 6 Switch and Display

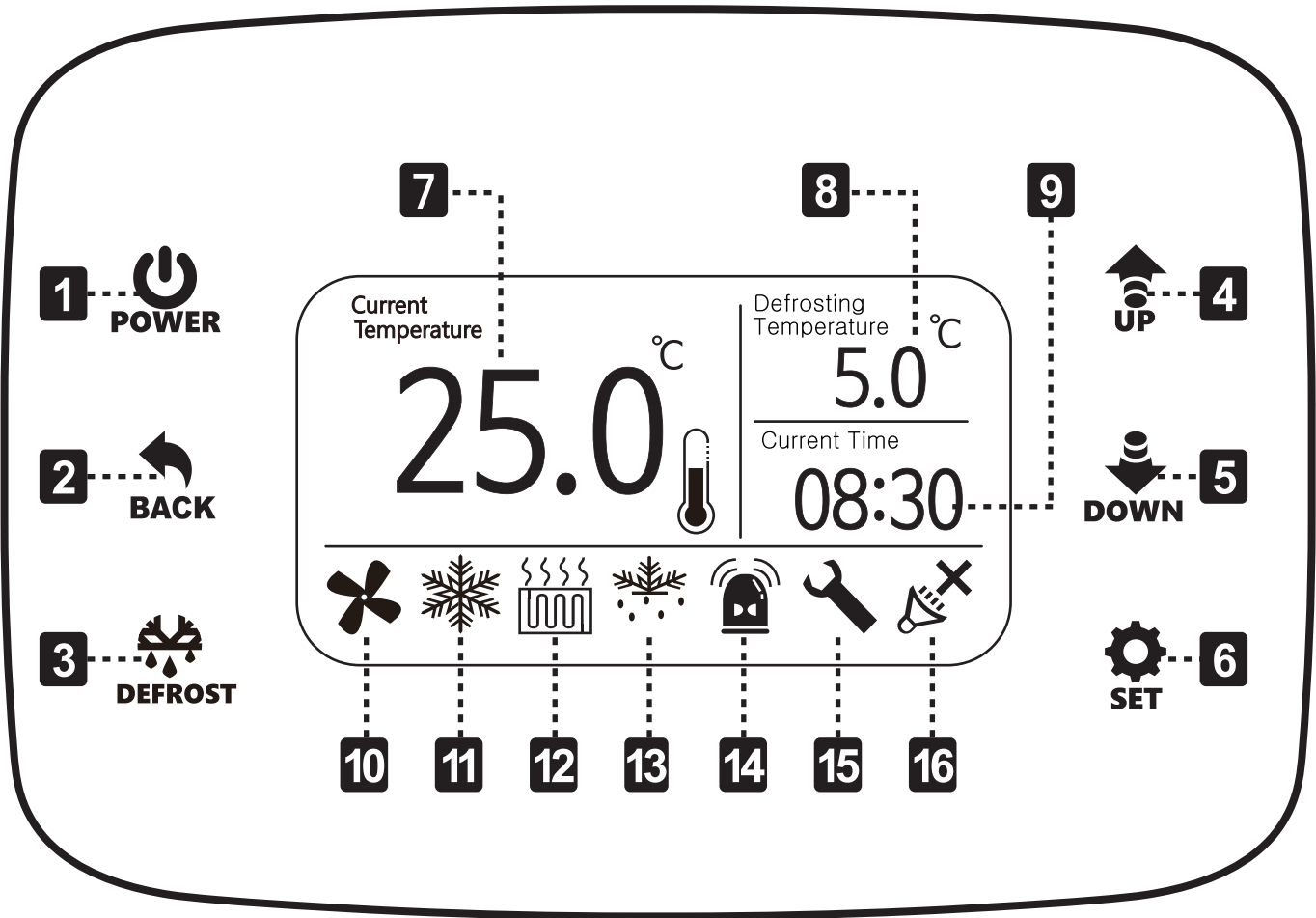

- 1** Power: A button to start or stop a system.
- 2** Cancel: A button to move to the previous menu at the time of setting or to return to the
- 3** Manual defrost : Manual defrosting by pressing for more than 5 seconds(see the 19P)
- 4** Top: A button to move to the menu in the setting or a button that increases the setpoint upon changing
- 5** Bottom: A button to move to the menu in the setting or a button that decreases the setpoint upon changing
- 6** Check: A button to enter the setting menu or to select setpoint.
- 7** Displays the current indoor temperature (PV) or sensor errors
- 8** Displays the defrosting temperature or sensor errors
- 9** Displays the current time
- 10** FAN output status icon
- 11** Pump(cooling) output status icon
- 12** Comp.(heating) output status icon
- 13** Defrosting output status icon
- 14** Alarm output status icon
- 15** Repair and maintenance alarm icon
- 16** Buzzer operation status icon

※ The output status icon is displayed only, and in delay time when not in operation.  
When the icon starts moving, the output will be ON.

# 7

## Menu Load Map

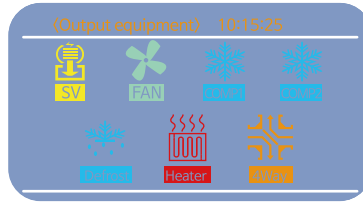
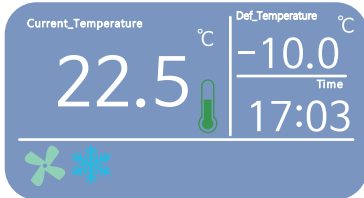

See 24Page



See 24Page

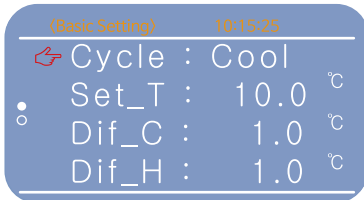

See 14Page

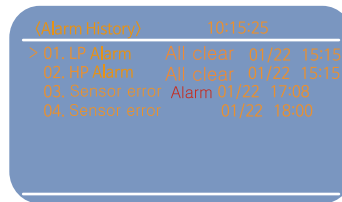

See 24Page

• Buzzor operation is  
See 25Page

Basic Setting
Cycle
Set_T
Dif_C
Dif_H
Set_M
Init

Output equipment
SV
FAN
COMP1
COMP2
Defrost
Heater
4Way

Alarm History
01. Event
02. Event
03. Event
⋮
20. Event

Calendar
Year
Month
Day
Week
Hour
Minute

Current\_Temperature 22.5 °C Def\_Temperature -10.0 °C  
Time 17:03



(Main Menu) 10:15:25  
 Set\_Detail  
 Set\_Defrost  
 Set\_Input  
 Set\_Alarm



Move menu

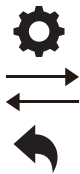

Main Menu
Set_Detail
Set_Defrost
Set_Input
Set_Alarm
Set_reserve
Set_Time
Check_Machine
Test_Output

(Set\_Detail) 10:15:25  
 Cp\_Dlt : 0s  
 Cp\_Dls : 10s  
 Set\_Pd : 0s  
 Set\_4Way : Cooling

See 15Page

(Set\_Defrost) 10:15:25  
 Cho\_Dty : Off  
 Cho\_Dtm : Ref  
 Set\_Dof : 4h  
 Set\_Don : 10m

See 18Page

(Set\_Input) 10:15:25  
 LP\_Input : N.C  
 LP\_Dt : 2s  
 HP\_Input : N.C  
 HP\_Dt : 2s

See 20Page

(Set\_Alarm) 10:15:25  
 Set\_Hpr : 99.9 °C  
 Set\_Lpr : -55.0 °C  
 Set\_Adf : 1.0 °C  
 FAN : 999d 23h

See 21Page

(Set\_reserve) 10:15:25  
 Sun : 00:00 ~ 00:00  
 Mon : 00:00 ~ 00:00  
 Tue : 00:00 ~ 00:00  
 Wed : 00:00 ~ 00:00

See 22Page

(Set\_Time) 10:15:25  
 Year : 2016  
 Month : 01  
 Day : 27  
 Hour : 20

See 22Page

(Check\_Machine) 10:15:25  
 FAN : 000d 09h  
 Comp1 : 000d 09h  
 Comp2 : 000d 00h  
 Def : 000d 00h

See 23Page

(Output status view) 10:15:25  
 FAN : Stop  
 Comp1 : Stop  
 Comp2 : Stop

See 23Page

Set_Detail
Cp_Dlt
Cp_Dls
Set_Pd
Set_4Way
Set_Fst
Fd_Dlt
Aux_H
Step_C
Step_H
Sig_ID
Sig_Sp
Cor_s1
Cor_s2
Set_Lang

Set_Defrost
Cho_Dty
Cho_Dtm
Set_Dof
Set_Don
Set_Dst
Set_Cms
Set_Det
Set_Ddt

Set_Input
LP_Input
LP_Dt
HP_Input
HP_Dt
OP_Input
OP_Dt

Set_Alarm
Set_Hpr
Set_Lpr
Set_Adf
FAN
COMP1
COMP2
Def
Aux_H

Set_reserve
Sun : Start ~ Stop time
Mon : Start ~ Stop time
Tue : Start ~ Stop time
Wed : Start ~ Stop time
Thu : Start ~ Stop time
Fri : Start ~ Stop time
Sat : Start ~ Stop time

Set_Time
Year
Month
Day
Hour
Minute
Second

Check_Machine
FAN
COMP1
COMP2
Def
Aux_H
Erase

Test_Output
FAN
COMP1
COMP2
Def
Aux_H
Alarm
SV
4Way

Application of operation stoppage

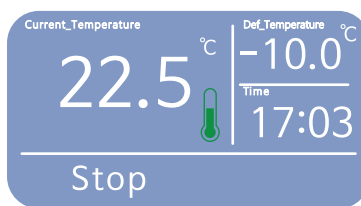
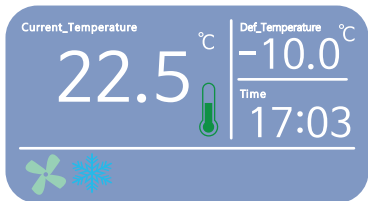

touch it for 5 seconds

Application of basic operation

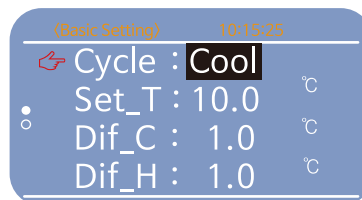
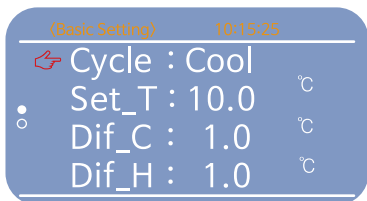
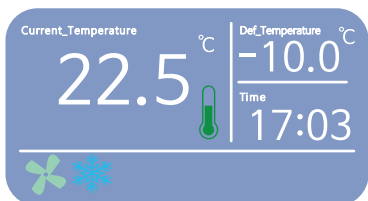

Set value changing



Main menu setting

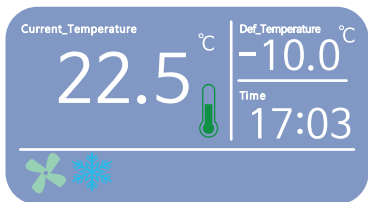

touch it for 5 seconds

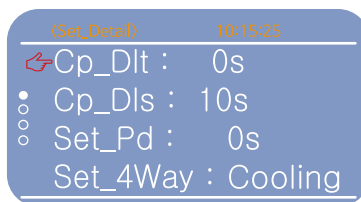

- In the state of operation stoppage – Saving completes
- In the state of operation – Saving fails

## 8 Program Menu Settings

### Basic operation settings

Items for Setting	Default	Setting range	Unit
Operation mode	Cooling	Cooling/Heating /Constant temp.	
Setting temp.	10.0	-55.0 ~ 99.9	°C
Cooler deviation	1.0	0.1 ~ 19.9	°C
Heater deviation	1.0	0.1 ~ 19.9	°C
Operation mode settings	General	General/Reservation	
Initialization	Cancel	Cancel/Use	

#### Operation mode

- Cooling : Setting at cooling operation
- Heating : Setting at heating operation
- Constant temp. : Setting at both operations(cooling/heating)

#### Setting Temperature

- Setup the basic temperature for operation of cooling/heating/constant temp.

#### Cooler deviation/Heater deviation

- A regular interval is required between ON and OFF in the ON/OFF control (set up ON/OFF width)
- Frequent ON and OFF will shorten the lifespan of the relay or the output contact or cause hunting (generation, chattering) by noise from outside. Temperature deviation function is used to setup temperature deviation to protect the equipment contact, etc.

#### When using in cooling

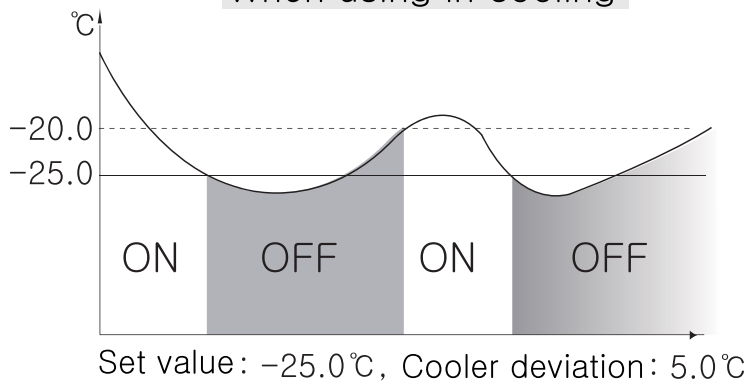

Current value > Setting value + Cooling deviation  
 → Output ON

Current value ≤ Setting value  
 → Output OFF

#### When using in heating

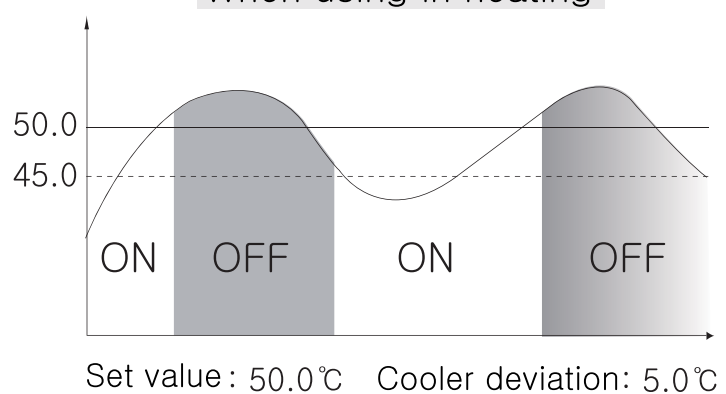

Current value < Setting value - Heater deviation  
 → Output ON

Current value ≥ Setting value  
 → Output OFF

## Operation mode setting

- General operation or Reservation operation setting
- When reservation, the equipment is operationed/stopped by the reserved time at operation/stop

## Value initialization

- Value initialized at factory

## ■ Detailed Operation Setting

Set Articles	Default	Setting Range	Unit
Comp.output delay	0	0 ~ 250	Sec
Comp.stop delay time	10	0 ~ 250	Sec
Pump down setting	0	0 ~ 250	Sec
4 ways value setting	Cooling	Cooling/Heating	
FAN output setting	F1	F1/F2/F3/F4	
FAN delay after defrosting	0	0 ~ 250	Sec
Sub heater	Cancel	Cancel/Use	
Cooling step setting	1Step	1Step/2Step	
Heating step setting	1Step	1Step/2Step	
Communication address	1	1 ~ 99	Number
Communication speed	9600	1200/2400/4800 /9600/19200	bps
Actual temperature correction	0.0	-10.0 ~ 10.0	°C
Defrosting temperature correction	0.0	-10.0 ~ 10.0	°C
Language	Kor	Kor/Eng	

## Comp. Delay Time

- If the control target repeats ON/OFF frequently and causes problems: (Freezer, compressor, etc.)
- A function to protect the machine in operation when power is re-applied or momentary power failure

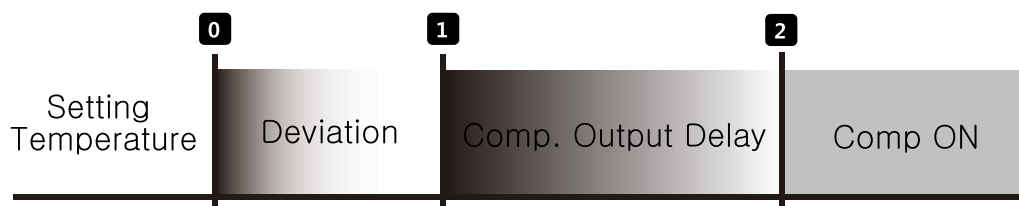

E.g.) Suppose the output delay time is 60 seconds, the delay time is (60 seconds) from **1** to **2** and the relay will be ON in **2** .



### Comp. Stop delay

- The function to setup the Comp. OFF after scheduled time and the electric valve OFF to protect the Comp.
- Stop delay time is applied when the Pump is down in cooling/heating/constant temperature after pump-down operation is terminated.

### Pump-down setting

- The function to setup the delay time until Comp. output comes to stop after the electric valve is OFF upon the termination of cooling/heating/thermostatic operation.
- When the pump is down, satisfy one condition from time or low pressure input to stop pump down operation.

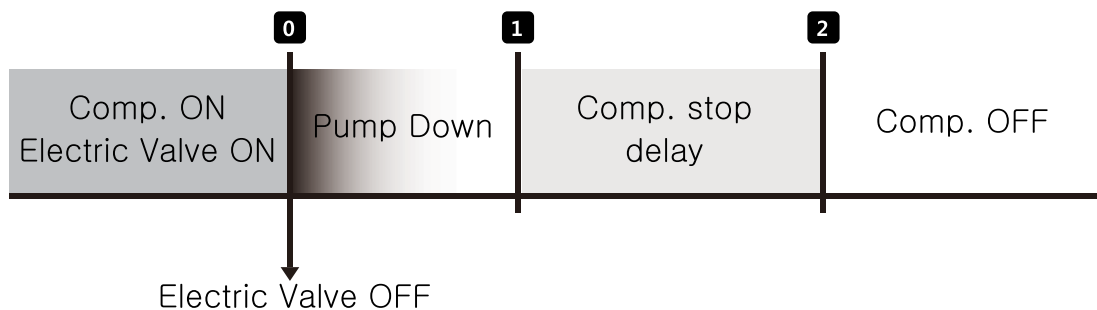

E.g.) Suppose pump down is 10 seconds and Comp. stop delay time is 10 seconds:  
 After the occurrence of electric valve OFF (0) section and the time (10 seconds) from (0) to (1), and Comp. OFF after time delay (10 seconds) from (1) to (2).

\* If pump down is 0 second(s), the Comp. stop delay will occur after COMP input signal

### 4 Ways Valve Setting

- 4 ways valve output setting
- Cooling : 4 ways valve output ON in cooling operation
- Heating : 4 ways valve output ON in heating operation

### FAN Output Setting

- See the chart of program setting for FAN(F1 ~ F4)

\* Chart

		COMP ON	COMP OFF	Defrost
FAN	F1	ON	OFF	OFF
	F2	ON	ON	ON
	F3	ON	OFF	ON
	F4	ON	ON	OFF

### FAN delay after defrosting

- FAN ON delay time after defrosting

e.g) Suppose delay time is 30 sec,

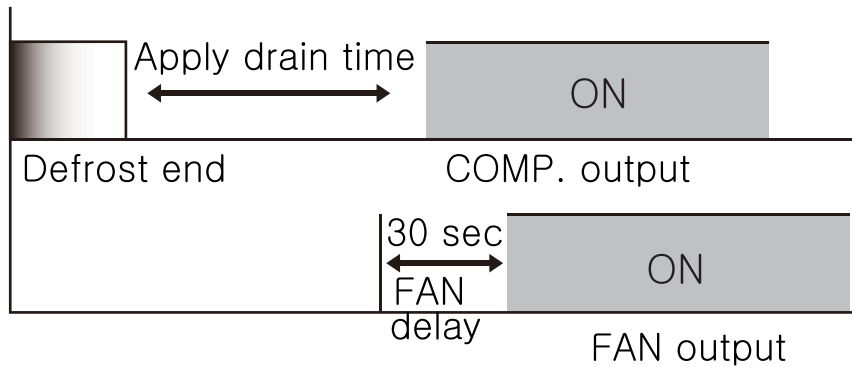

### Sub-heater

- Setting whether to use auxiliary heater when heating

### Cooling Step Setting

- 1Step : COMP 1 output in cooling
- 2Step : COMP 1, COMP2 output in cooling

### Heating Step Setting

- 1Step : COMP 1 output in heating
- 2Step : COMP 1, COMP2 output in heating

### Communication Code No.

- To use the RS485 communication, appoint area codes from 1 to 99.

### Communication speed

- Adjust communication speed
- 1200BPS / 2400BPS / 4800BPS / 9600BPS / 19200BPS

### Indoor temperature correction

- Indoor sensor temperature correction

### Defrost temperature correction

- Defrosting sensor temperature correction

※It is the function to correct errors in the sensor put in from the outside even if there is no problem in the product, and when the base temperature (Ex: mercury thermometer, or existing temperature, temperature controller) is different with the temperature.

## Language

- Setting in Korean or English

## ■ Defrost Setting

Setting items	Default	Setting Range	Unit
Defrost type	Not use	Not use/Electrical defrost Hot gas/Reverse cycle	
Defrost mode	Cyclic defrost	Cyclic defrost/Temp. defrost /COMP cumulative	
Defrost stop time	4	1 ~ 250	Hour
Defrost start time	10	1 ~ 250	Min.
Start temp.	-10.0	-55.0 ~ 99.9	°C
COMP cumulative time	3	1 ~ 250	Hour
Heating prevention	50.0	-55.0 ~ 99.9	°C
Drain time setting	0	0 ~ 250	Sec

## Defrosting system

- Not using : Select when not using defrost
- Electrical defrosting : COMP OFF in defrosting
- Hot gas defrosting : COMP ON in defrosting
- Reverse cycle defrosting :  
In case of defrosting occurs during cooling operation,  
defrosting output and heating operation are operated, and after defrosting  
time is completed, it is switched to cooling operation.  
In case of defrosting occurs during heating operation,  
defrosting output and cooling operation are operated, and after defrosting  
time is completed, it is switched to heating operation.

## Defrosting operation

- Cyclic defrost : Defrosting OFF during defrost stopping time  
→ Defrosting ON during defrost start time
- Temp.defrost : Defrost by the Sensor temp.for defrost
- COMP cumulative defrost : Defrosting by COMP cumulative time

## Defrosting stop time

- Time to defrost is OFF incase of cyclic defrost.

## Defrosting start time

- Time to defrost is ON in case of cyclic defrost/temp.defrost/COMP  
culmulative defrost.

e.g) Defrosting time(4 hours), Defrosting start time(10 minutes)

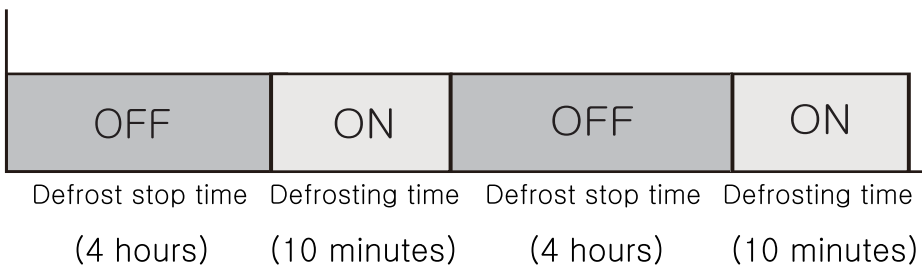

Repeats defrost operation for 10 minutes every 4 hours

### Start temperature

- Defrost start point when temperature defrosting
- When defrost sensor temperature is less than defrost start value, defrost ON during defrost start time

### COMP cumulative time

- Defrost start point when COMP cumulative defrost
- Defrost ON during defrost start time , when the accumulation time of the compressor is longer than the comp accumulation time set value.

### Heating prevention

- After the defrosting is finished, all outputs are turned OFF by the set time, and the COMP output is turned ON.
- When the defrost sensor temperature is above the heating prevention temperature, defrost OFF.



### Drain time setting

- After the defrosting is finished, all outputs are turned OFF by the set time, and the COMP output is turned ON.

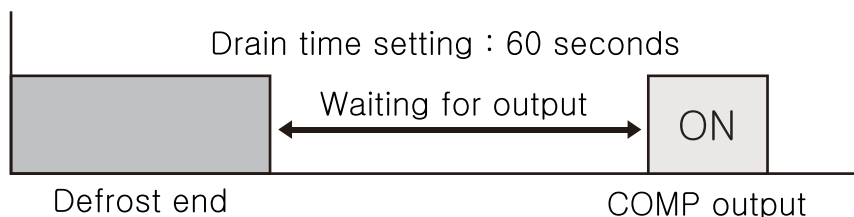
E.g.) Suppose drain time setting is 60 seconds,



### Manual defrosting method

1. Manual defrosting ON : Pressing the  key for 5 seconds or longer will start defrosting for the defrost start time
2. Manual defrosting OFF : Pressing the  key for 5 seconds or longer will finish defrosting in the state of manual defrosting ON.

## ■ Input Setting

Setting items	Default	Setting Range	Unit
LP Input	N.C	N.C/N.O	
LP detective time	2 sec	0 ~ 250	Sec
HP Input	N.C	N.C/N.O	
HP detective time	2 sec	0 ~ 250	Sec
OP Input	N.C	N.C/N.O	
OP detective time	2 sec	0 ~ 250	Sec

### LP Input

- Low pressure switch
- N.C(Normal Close) / N.O(Normal Open)

### LP detective time

- Function to set the detection time so that an alarm is generated when a signal is detected or not detected at the LP input for the set time after the output of the liquid pipe solenoid valve.
- However, when set to '0', low pressure abnormality does not occur.

### HP Input

- High pressure switch
- N.C(Normal Close) / N.O(Normal Open)

### HP detective time

- When setting the detection time so that an alarm is generated if a signal is detected or not detected at the HP input during the set time.
- However, when set to '0', no high voltage error will occur.

### OP Input

- Oil pressure switch
- N.C(Normal Close) / N.O(Normal Open)

### OP detective time

- Function to set the detection time so that an alarm is generated when a signal is detected or not detected on the OP input during the set time.
- However, when set to '0', no oil pressure error will occur.

## ■ Alarm Setting

Setting Articles	Default	Setting range	Unit
High temperature alarm	99.9	-55.0 ~ 99.9	°C
Low temperature alarm	55.0	-55.0 ~ 99.9	°C
Alarm deviation	1.0	0.1 ~ 19.9	°C
FAN	999 days 23 hours	0 day 0 hour ~999 days 23 hours	Day, hour
COMP1			
COMP2			
Defrost			
Aux. heater			

### High temperature alarm

- Sets the point at which a high temperature alarm occurs when the current temperature is above a certain temperature.
- High temperature alarm : When current value is higher than high temperature set value.
- Release after high temperature alarm : When the current temperature is lower than (High temperature alarm set value - alarm deviation set value)

### Low temperature alarm

- Sets the point at which the low temperature alarm occurs when the current temperature is below a certain temperature.
- Low temperature alarm occurrence : When the current temperature is below the low temperature alarm set value
- Release after low temperature alarm: When the current temperature is higher than (low temperature alarm set value + alarm deviation set value)

### Alarm deviation

- It sets the hysteresis width between ON and OFF of alarm occurrence, and both high temperature alarm and low temperature alarm are applied.

### FAN

- When the fan output time (day, hour) is larger than the fan setting time (day, hour), the maintenance alarm sounds. However, if the fan setting time is not '0 day 0 hour'.

### COMP1

- The maintenance alarm sounds when the time (day, hour) at which COMP1 is output from the COMP1 set time (day, hour) is longer. However, if the COMP 1 setting time is not '0 day 0 hour'.

### COMP2

- The maintenance alarm sounds when the COMP2 output time (day, hour) is longer than the COMP2 set time (day, hour) is longer. However, if the Comp 2 setting time is not '0 day 0 hour'.

## Defrost

- If the defrosting time (day, hour) is longer than the defrosting output time (day, hour), the maintenance alarm sounds.  
However, if the defrost set time is not '0 day 0 hour'

## Aux. Heater

- Maintenance alarm is sounded when the time of auxiliary heater output (day, hour) is longer than auxiliary heater setting time (day, hour). However, if the auxiliary heater setting time is not '0 day 0 hour'.

## ■ Operation Reservation Setting

Setting items	Operation time ~ Stop time
(Sunday)	12:00 ~ 12:00
(Monday)	08:30 ~ 14:30
(Tuesday)	11:00 ~ 18:00
(Wednesday)	15:00 ~ 19:00
(Thursday)	21:00 ~ 16:00
(Friday)	01:20 ~ 17:30
(Saturday)	18:10 ~ 22:10

- It is used to operate the equipment at the set operating time and to stop the equipment at the set stop time.(However, if the operation mode setting is set as a reservation.
- If it is not operated on a specific day, set the operation time and stop time to be the same or set the operation time to be longer than the stop time.
- If the operation time is after the stop time, it will not operate.
- During reserved operation, you can operate / stop by operation / stop button.
- After the stop time, pressing the start / stop button does not operate.

## ■ Current time setting

Setting Items	Setting Range	Unit
(Year)	2010 ~ 2099	Year
(Month)	1 ~ 12	Month
(Day)	1 ~ 31	Day
(Hour)	0 ~ 23	Hour
(Minute)	0 ~ 59	Minute
(Second)	0 ~ 59	Second

- The current time setting is used as the basis for recording the system status data in the alarm history and the reference operation start date. Therefore, when there is a problem with the equipment, it is necessary to set the date and time for the cause analysis.

### ■ Check operation status

Items	Display range	Unit
FAN	0 day 0 hour ~ 999 days 23 hours	Day, hour
COMP1		
COMP2		
Defrost		
Aux.heater		
Delete all	Delete/Cancel	

- The operation time of each output is checked, and it is saved in 1 hour unit.
- It is the basis for the repair and maintenance of the alarm setting.
- When the deletion is performed from the whole deletion, the accumulated contents of each output becomes '0'.

### ■ Equipment output test

Setting items	Default	Setting Range
FAN	STOP	Operate/STOP
COMP1		
COMP2		
Defrost		
Aux.heater		
Integral alarm		
SV		
4 ways		



- Used when the engineer runs the test .
- Test all outputs after stopping operation.

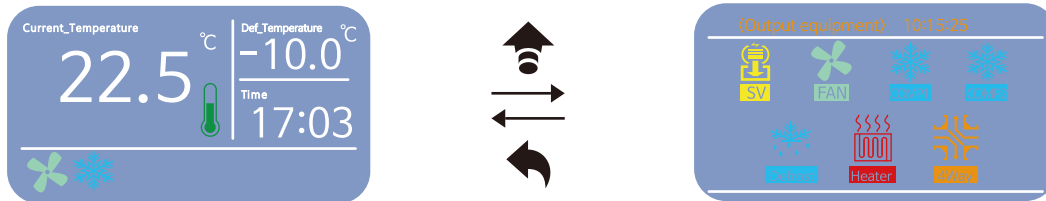

## 9 System information menu

### ■ Equipment Output Check



- Equipment output displays if touch  key in the operation display.
- Status icons(SV, FAN, Comp1, Comp2, Defrost, Sub-heater, 4 ways) displays depends on the output.
- Returns to the operation display if touch  key.

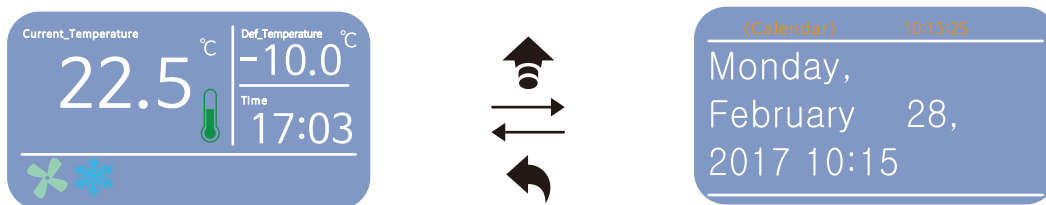

### ■ Calendar



- Calendar displays if touch  key in the operation display.
- Able to check the current date and time.
- Returns to the operation display if touch  key.

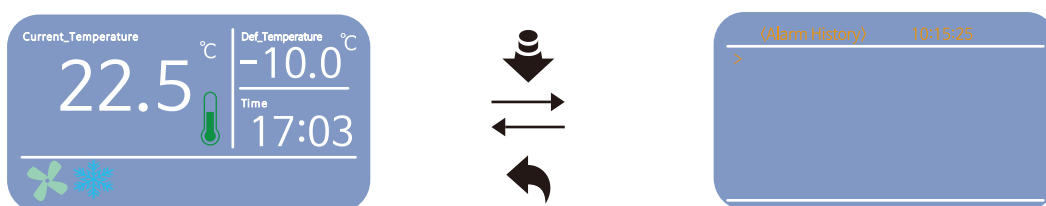

### ■ Alarm history

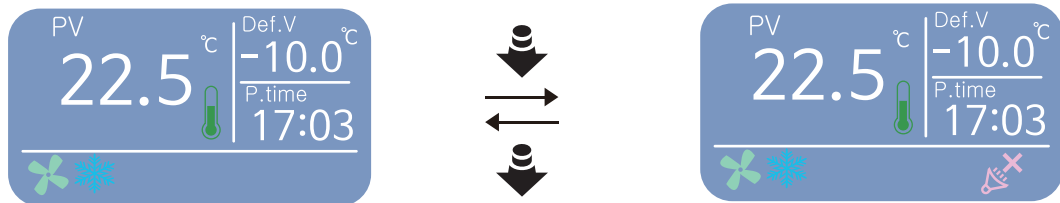

- Alarm history displays if touch  key in the operation display.
- When an alarm is generated (released), the date and time and alarm name are stored in nonvolatile memory.
- The maximum number of storages is 20, and if it is more than 20, the first event is deleted and stored.
- All alarm history records are removed if touch  key for 5 seconds.
- Returns to the operation display if touch  key.

## ■ Buzzer operation



- It uses when making the buzzer sound stop.
- Buzzer OFF : When the buzzer ON, mute icon shows if touching  for 5 seconds.
- Buzzer ON : When the buzzer OFF, mute icon doesn't show if touching  for 5 seconds.

## ■ Alarm Type

NO	Alarm contents	Alarm/release conditions
01	High temperature alarm	Alarm : Indoor temperature $\geq$ High temperature alarm Release : Indoor temperature $<$ (High temp. alarm-alarm dev.)
02	Low temperature alarm	Alarm : Indoor temperature $\leq$ Low temperature alarm Release : Indoor temperature $>$ (Low temp. alarm + alarm dev.)
03	LP alarm	Alarm : N.C(No signal), N.O(Signal detective) Release : N.C(Signal detective), N.O(No signal)
04	HP alarm	Alarm : N.C(No signal), N.O(Signal detective) Release : N.C(Signal detective), N.O(No signal)
05	OP alarm	Alarm : N.C(No signal), N.O(Signal detective) Release : N.C(Signal detective), N.O(No signal)
06	Request to repair FAN	Alarm : FAN output time $\geq$ FAN alarm time Release : FAN output time $<$ FAN alarm time If FAN alarm time is '0 day 0 hour'
07	Request to repair COMP1	Alarm : COMP1 output time $\geq$ COMP1 alarm time Release : COMP1 output time $<$ COMP1 alarm time If COMP1 alarm time is '0 day 0 hour'
08	Request to repair COMP2	Alarm : COMP2 output time $\geq$ COMP2 alarm time Release : COMP2 output time $<$ COMP2 alarm time If COMP2 alarm time is '0 day 0 hour'
09	Request to repair defrost	Alarm : COMP2 output time $\geq$ COMP2 alarm time Release : COMP2 output time $<$ COMP2 alarm time If COMP2 alarm time is '0 day 0 hour'
10	Request to repair auxiliary heater	Alarm : Aux.heater output time $\geq$ Aux.heater alarm time Release : Aux.heater output time $<$ Aux.heater alarm time If Aux.heater alarm time is '0 day 0 hour'
11	Temperature sensor error in warehouse	Alarm : If the warehouse internal temperature sensor is disconnected or short-circuited. Release : If the warehouse internal temperature sensor is normal.
12	Defrost temperature sensor error	Alarm : If the warehouse internal temperature sensor is disconnected or short-circuited. Release : If the warehouse internal temperature sensor is normal.

# 10 Modbus-RTU

## Interface

Applicable Standard	EIA RS485 Conformity
Communication Method	2-wire half-duplex
Communication Style	Asynchronous
Communication Distance	Within 1.2Km
Communication Speed	1200/2400/4800/9600/19200bps(Selectable)
Start Bit	1 Bit fixed
Stop Bit	1 Bit fixed
Parity Bit	None
Data Bit	8 Bit Fixed
Protocol	Modbus-RTU

## System Composition

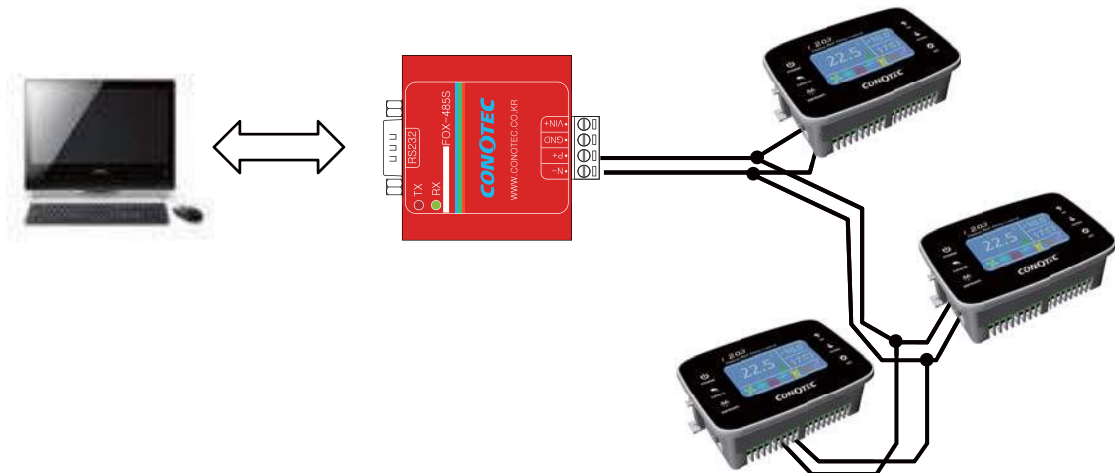
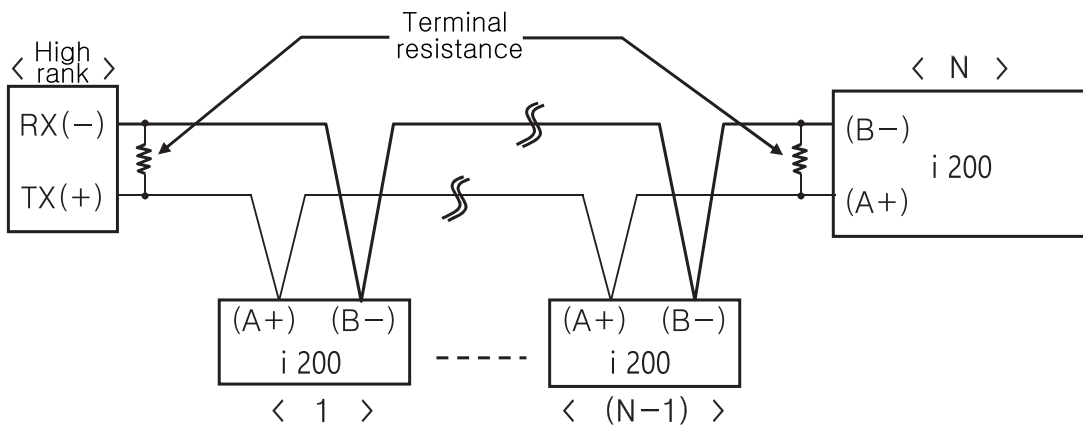

- "RS485" is for 1: N communication using RS485 communication standard. At this time, this unit becomes a SLAVE unit. A separate RS485 to 232 converter is required to communicate with the PC program (A separate purchase).

For communication cable, please use Twise Pair (BELDEN8761) suitable for RS485 communication.

## ■ Modbus RTU Composition

- Communication Protocol for i200 is Modbus RTU.
- When a Query is sent from the higher system(Master), the product (Slave) sends a response.

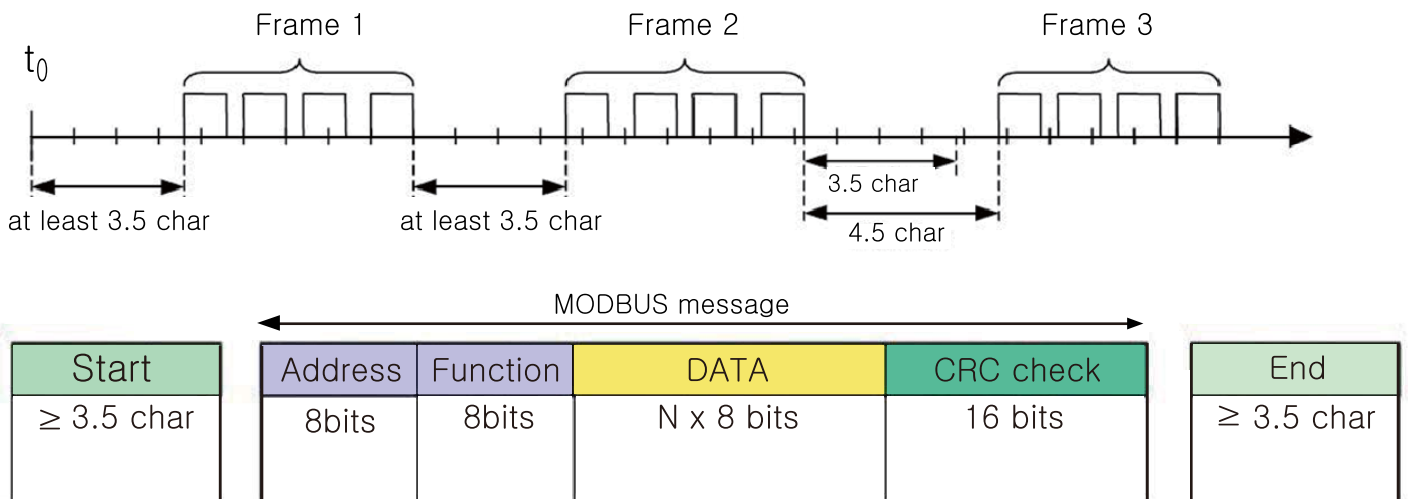

## ■ Definitions of communication Command and Block

<High rank(HOST) Query(Question) Format>

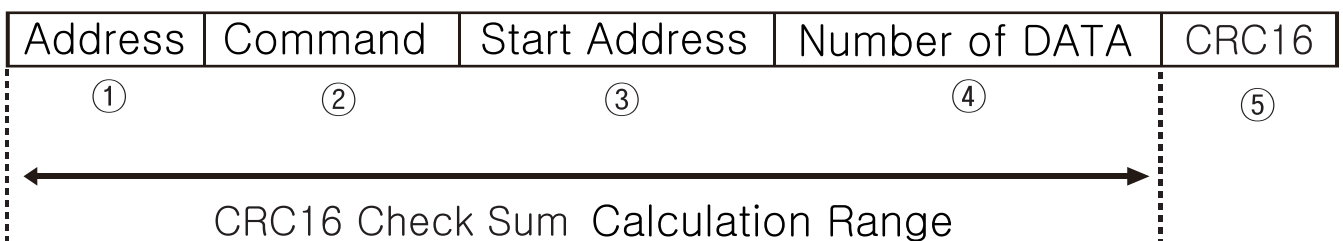

- ① Address : Address code that upper system identifies i200, and can be set within the range of 1-99.
- ② Command: Input register read command
- ③ Start address: The start address of the input register to read.
- ④ Number of Data: Number of Points (16 bits) to be read from the start address
- ⑤ CRC16 : As Check Sum that checks the entire block, it is a code to monitor the error that may occur in transmission of data between sender and receiver more accurately and to guarantee the transmission and reception of accurate data by requesting retransmission.

<i 200 Response format >

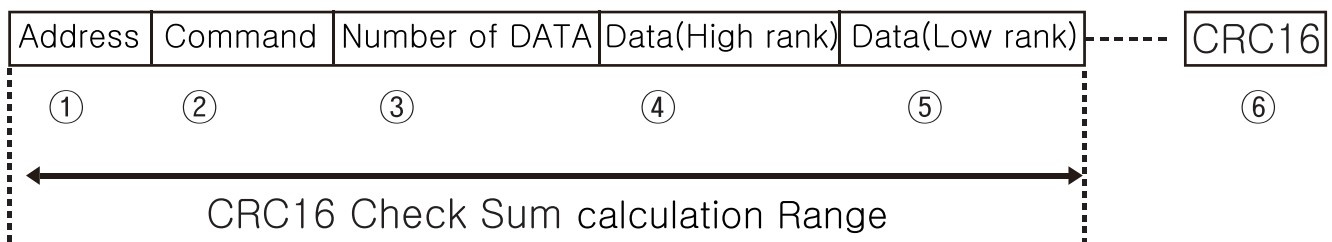

- ① Address : Address code that upper system identifies i200, and can be set within the range of 1 ~ 99.
- ② Command : Input Register reading Command(See the Modbus Mapping Table)
- ③ Number of Data : 8Bit Number of Data to read from start address(See the Modbus Mapping Table)
- ④ Data(High rank) : The upper data of the read value(1Byte)
- ⑤ Data(Low rank) : The lower data of the read value(1Byte)
- ⑥ CRC16 : Check sum code that checks whole Block.

<Error process >



- Exception: (01H) If the command is not supported.  
 code (02H) If the start address of the requested data is inconsistent with the address that the device can transmit.  
 (03H) If the number of requested data is inconsistent with the number that can be transmitted by the device.  
 (04H) If the requested command can not be processed normally.

## ■ Modbus Mapping Table

<Read Coils(Func01)/Write Single Coil(Func05)>

NO	Address	Items	Setting Range	Unit	Remark
000001	0000		0:Operation 1:STOP		

<Read Discrete Input(Func02)>

NO	Address	Items	Setting Range	Unit	Remark
100001	0000	COMP1	0:OFF 1:ON	Bit1	
100002	0001	COMP2	0:OFF 1:ON	Bit2	
100003	0002	FAN	0:OFF 1:ON	Bit3	
100004	0003	Defrost	0:OFF 1:ON	Bit4	
100005	0004	Aux.heater	0:OFF 1:ON	Bit5	
100006	0005	SV	0:OFF 1:ON	Bit6	
100007	0006	4WAY	0:OFF 1:ON	Bit7	
100008	0007	Alarm	0:OFF 1:ON	Bit8	
100009	0008	Correction	0:OFF 1:ON	Bit9	
100010	0009	LP Input	0:OFF 1:ON	Bit10	
100011	0010	HP Input	0:OFF 1:ON	Bit11	
100012	0011	OP Input	0:OFF 1:ON	Bit12	
100013	0012	Mute	0:OFF 1:ON	Bit13	

<Read Input Registers(Func04)>

\* Main display

NO	Address	Items	Setting Range	Unit	Remark
300001	0000	Indoor temp.	-550~999:-55.0~99.9	℃	
300002	0001	Defrost temp.	-550~999:-55.0~99.9	℃	
300003	0002	COMP1	0:OFF 1:ON	Bit1	
		COMP2	0:OFF 1:ON	Bit2	
		FAN	0:OFF 1:ON	Bit3	
		Defrost	0:OFF 1:ON	Bit4	
		Aux.heater	0:OFF 1:ON	Bit5	
		SV	0:OFF 1:ON	Bit6	
		4WAY	0:OFF 1:ON	Bit7	
		Alarm	0:OFF 1:ON	Bit8	
		Correction	0:OFF 1:ON	Bit9	
		LP Input	0:OFF 1:ON	Bit10	
		HP Input	0:OFF 1:ON	Bit11	

\* Alarm displays

NO	Address	Items	Setting Range	Unit	Remark
300003	0002	OP input	0:OFF 1:ON	Bit12	
		Mute	0:OFF 1:ON	Bit13	
300004	0003	Year	2010 ~ 2099	Year	
300005	0004	Month	1 ~ 12	Month	
300006	0005	Date	1 ~ 31	Date	
300007	0006	Day	0:Sun 1:Mon 2:Tue 3: Wed 4:Thur 5:Fri 6:Sat	Day	
300008	0007	Hour	0 ~ 23	Hour	
300009	0008	Minute	0 ~ 59	Min	
300010	0009	Second	0 ~ 59	Second	

NO	Address	Items	Setting Range	Unit	Remark
301001	03E8	Menu	0 ~ 12		See the table
301002	03E9		0:Release 1: Alarm		
301003	03EA	Month	1 ~ 12	Month	
301004	03EB	Date	1 ~ 31	Date	
301005	03EC	Hour	0 ~ 23	Hour	
301006	03ED	Minute	0 ~ 59	Minute	
301007	03EE	Menu	0 ~ 12		See the table
301008	03EF		0:Release 1: Alarm		
301009	03F0	Month	1 ~ 12	Month	
301010	03F1	Date	1 ~ 31	Date	
301011	03F2	Hour	0 ~ 23	Hour	
301012	03F3	Minute	0 ~ 59	Minute	

<See the table>	Menu	Description
		0: None 1: High temp. alarm 2: Low temp. alarm 3. LP alarm 4: HP alarm 5: OP alarm 6: FAN correction requirement 7: COMP1 correction requirement 8: COMP2 correction requirement 9: Defrost correction requirement 10: Aux.Heater correction requirement 11: Storage temp. sensor error 12: Defrosting temp. correction requirement

NO	Address	Items	Setting Range	Unit	Remark
301115	045A	Menu	0 ~ 12		See the table
301116	045B		0:Release 1: Alarm		
301117	045C	Month	1 ~ 12	Month	
301118	045D	Date	1 ~ 31	Date	
301119	045E	Hour	0 ~ 23	Hour	
301120	045F	Minute	0 ~ 59	Minute	

\* Output time display

NO	Address	Item	Setting range	Unit	Remark
302001	07D0	FAN output time	0 ~ 999	Day	
302002	07D1		0 ~ 23	Hour	
302003	07D2	COMP 1 output time	0 ~ 999	Day	
302004	07D3		0 ~ 23	Hour	
302005	07D4	COMP 2 output time	0 ~ 999	Day	
302006	07D5		0 ~ 23	Hour	
302007	07D6	Defrost output time	0 ~ 999	Day	
302008	07D7		0 ~ 23	Hour	
302009	07D8	Aux.heater output time	0 ~ 999	Day	
302010	07D9		0 ~ 23	Hour	

<Read Holding Register(Func03)/Write Single Register(Func06)/  
Write Multiple Register(Func16)>

\* Basic operation setting

NO	Address	Operation	Setting range	Unit	Remark
400001	0000	Operation method	0:Cooling 1:Heating 2:Constant temperature		
400002	0001	Setting temperation	-550~999:-55.0~99.9	℃	
400003	0002	Cooler deviation	1~199:0.1~19.9	℃	
400004	0003	Heater deviation	1~199:0.1~19.9	℃	
400005	0004	Operation mode setting	0:normal 1:reservation		
400006	0005	Factory initialization	0:cancel 1:use		
400007	0006	Alarm history initialized	0:cancel 1:delete		
400008	0007	Status initialization	0:cancel 1:delete		

\* Operation setting in details

	Address	Operation	Setting range	Unit	Remark
400009	0008	Comp.output delay	0 ~ 250	sec	
400010	0009	Comp. stop delay	0 ~ 250	sec	
400011	000A	Pump down setting	0 ~ 250	sec	
400012	000B	4-way valve setting	0:cooling 1:heating		
400013	000C	Fan output setting	0:F1 1:F2 2:F3 3:F4		
400014	000D	Fan delay after defrost	0 ~ 250	sec	
400015	000E	Aux. heater			
400016	000F	Cooling step setting	0:1 step 1:2 step		
400017	0010	Heating step setting	0:1 step 1:2 step		
400018	0011	Comm.address	1 ~ 99	number	



NO	Address	Items	Setting Range	Unit	Remark
400019	0012	Communication Speed	0:1200 1:2400 2:4800 3:9600 4:19200	bps	
400020	0013	Room temp. correct	-100 ~100:-10.0~10.0	°C	
400021	0014	Defrost temp. correct	-100 ~100:-10.0~10.0	°C	
400022	0015	Language	0:KOR 1:Eng		

\* Set to defrost

NO	Address	Items	Setting Range	Unit	Remark
400023	0016	Defrost method	0:Not use 1: Electric defrost 2:Hot gas 3: Cycle reversing		
400024	0017	Operate to defrost	0:Cycle defrost 1: Temp.defrost 2:Comp accumulation		
400025	0018	Defrost stop time	0 ~ 250	Hour	
400026	0019	Defrost start time	0 ~ 250	Minute	
400027	001A	Start temperature	-550~999 -55.0~99.9	°C	
400028	001B	Comp accumulation time	0 ~ 250	Hour	
400029	001C	Heat prevention	-550~999:-55.0~99.9	°C	
400030	001D	Set drain time	0 ~ 250	Sec	

\* Set to input

NO	Address	Items	Setting Range	Unit	Remark
400031	001E	LP input	0:N.C 1:N.O		
400032	001F	LP detective time	0 ~ 250	Sec	
400033	0020	HP input	0:N.C 1:N.O		
400034	0021	HP detective time	0 ~ 250	Sec	
400035	0022	OP input	0:N.C 1:N.O		
400036	0023	OP detective time	0 ~ 250	Sec	

\* Set to alarm

NO	Address	Items	Setting range	Unit	Remark
400037	0024	High temp. alarm	-550~999:-55.0~99.9	°C	
400038	0025	Low temp. alarm	-550~999:-55.0~99.9	°C	
400039	0026	Alarm deviation	1~199:0.1~19.9	°C	
400040	0027	FAN	0 ~ 999	Day	
400041	0028		0 ~ 23	Hour	
400042	0029	COMP1	0 ~ 999	Day	
400043	002A		0 ~ 23	Hour	

NO	Address	Items	Setting Range	Unit	Remark
400044	002B	COMP2	0 ~ 999	Day	
400045	002C		0 ~ 23	Hour	
400046	002D	Defrosting	0 ~ 999	Day	
400047	002E		0 ~ 23	Hour	
400048	002F	Aux. heater	0 ~ 999	Day	
400049	0030		0 ~ 23	Hour	

\* Operation reservation setting

NO	Address	Items	Setting Range	Unit	Remark
400050	0031	Sunday (Start time)	0 ~ 23	Hour	
400051	0032		0 ~ 59	Minute	
400052	0033	Sunday (End time)	0 ~ 23	Hour	
400053	0034		0 ~ 59	Minute	
400054	0035	Monday (Start time)	0 ~ 23	Hour	
400055	0036		0 ~ 59	Minute	
400056	0037	Monday (End time)	0 ~ 23	Hour	
400057	0038		0 ~ 59	Minute	
400058	0039	Tuesday (Start time)	0 ~ 23	Hour	
400059	003A		0 ~ 59	Minute	
400060	003B	Tuesday (End time)	0 ~ 23	Hour	
400061	003C		0 ~ 59	Minute	
400062	003D	Wednesday (Start time)	0 ~ 23	Hour	
400063	003E		0 ~ 59	Minute	
400064	003F	Wednesday (End time)	0 ~ 23	Hour	
400065	0040		0 ~ 59	Minute	
400066	0041	Thursday (Start time)	0 ~ 23	Hour	
400067	0042		0 ~ 59	Minute	
400068	0043	Thursday (End time)	0 ~ 23	Hour	
400069	0044		0 ~ 59	Minute	
400070	0045	Friday (Start time)	0 ~ 23	Hour	
400071	0046		0 ~ 59	Minute	
400072	0047	Friday (End time)	0 ~ 23	Hour	
400073	0048		0 ~ 59	Minute	
400074	0049	Saturday (Start time)	0 ~ 23	Hour	
400075	004A		0 ~ 59	Minute	
400076	004B	Saturday (End time)	0 ~ 23	Hour	
400077	004C		0 ~ 59	Minute	

\* Current time setting

NO	Address	Items	Setting Range	Unit	
400078	004D	Year	2010 ~ 2099	Year	
400079	004E	Month	1 ~ 12	Month	
400080	004F	Day	1 ~ 31	Day	
400081	0050	Hour	0 ~ 23	Hour	
400082	0051	Minute	0 ~ 59	Minute	
400083	0052	Second	0 ~ 59	Second	

\* Equipment output test

NO	Address	Items	Setting Range	Unit	Remark
400084	0053	FAN	0: Stop 1: ON		
400085	0054	COMP1			
400086	0055	COMP2			
400087	0056	Defrost			
400088	0057	Aux.Heater			
400089	0058	Multi-Alarm			
400090	0059	SV			
400091	005A	4 Way			

## 11 Error Display

■ Open error

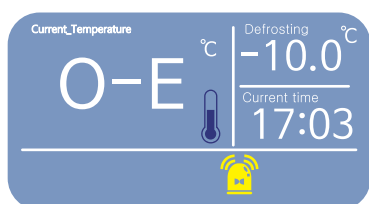

- Error displays in case of the sensor disconnected

■ Short error

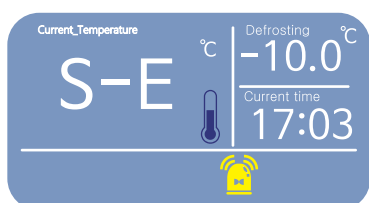

- Error displays in case of the sensor shorted

■ Memory error

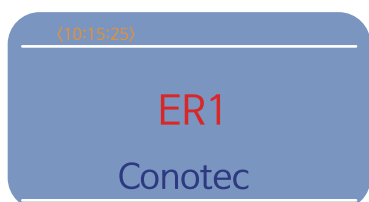

- Error displays in case of damaged on the various DATA memory elements caused by strong noise from outside in using.

# Product Warranty

This product was manufactured after undergoing strict quality management and tests of CONOTEC Inc. The warranty period of this product will be one year after purchase in accordance with the Consumer Injury Compensation Rule. So, please certainly write down the purchasing date and place at the place where the product is purchased.

If the user is failed to write down the information, the warranty will be one year and six months since the release date.

Product Name	
Model Name:	
Purchasing Date	YYYY      MM      DD
Purchasing Place	

Please prepare this Product Warranty when there is a default in manufacturing or natural malfunction within the period of Product Warranty and visit the purchasing place of main office of CONOTEC for the free repair.

Repair cost can be charged for the following cases or the Warranty period is passed.

- Please be sure to read this manual instruction. If a user requests After Service and the product has no problem, certain cost will be charged.
- In case of malfunction due to carelessness of a user or that a user fixes or remodels the product arbitrarily
- In case of malfunction due to wrong electric capacity
- In case of malfunction due to shocks like fallings
- In case that a user does not abide by this manual instruction
- In case of malfunction due to natural disasters (Fire, Flood damage, Earthquake, Lighting, etc.)

### **A/S center**

- Purchasing place
- A/S Department under CONOTEC Quality Management Division : T: 070-7815-8266, F: 051-819-4562

# MEMO

**MEMO**

# MEMO



This instruction includes ownership information protected by the Copyright.

All rights will be owned by the Copyright owner. This instruction must not be copied, manufactured or translated into other languages without CONOTEC's approval signature.

Reporting Date: Feb 24, 2016 Manual Version: V1.0