



Operating manual



FOX-2SH(R) (temperature/humidity)

FOX-2H (humidity)

FOX-2H-2 (humidity)

※ Thank you for selecting our products. please read carefully this instruction to reduce any damages or operation mistakes.

1 Model composition

Model	Output	Sensor	Humidity range	RS485
FOX-2H	Main:1c 250Vac2A	HM1500	0.0%~100.0%Rh	-
FOX-2H-2	Aux:1a 250Vac2A	HM1500	0.0%~100.0%Rh	-
FOX-2SH	Main:1a 250Vac2A	DS-SH series	0.0%~100.0%Rh	-
FOX-2SHR	Aux:1a 250Vac2A	DS-SH series	0.0%~100.0%Rh	support

2 Safety and Hazard instructions

Safety

Please use this item after installing the duplex safety device in which is applied at dangerous factors such as serious human injury or serious damages of property & important machine because this item is not designed as safety device.

safety instruction and hazard warnings

1. Please read the operating manual through completely before putting the device into operation.
2. We will not assume any responsibility for damage to assets or persons caused by improper handling or failure to observe the safety instructions or hazard warnings.
3. For safety and licensing reason, unauthorized conversion and/or modification of the device is not permitted.
4. Do not exceed the maximum permissible current – in case of higher loads, use a contactor of adequate power. Make sure that the supplied voltage matches the values specified for the instrument.
5. The device must be adequately protected from water and dust as per the application and must be accessible via the use of appropriate tools.
6. The device must not be exposed to extreme temperature, sunlight, strong vibrations or high levels of humidity.
7. Operation or installation in not permitted under unfavorable ambient conditions such as wetness or excessive induction loads or solenoid and dust, combustible gases, vapors or solvents, especially high-frequency noise.
8. Avoid operation or installation close to high-frequency fields such as welding devices, sewing machines, wireless transmitter, radio systems, SCR controller, etc
9. Do not install the sensor cable nearby signal cable, power cable, load cable.
10. Please use the shield cable when the sensor cable's lengthen, however do not make it too much longer.
11. Please use the sensor cable without any cutting or flaw, blemish.
12. The device is not a toy and should be kept away from children.
13. installation work must only be carried out by suitably qualified personnel who are familiar with the hazards involved and with the relevant regulations.
14. you shouldn't tinker with anything or the product may not be opened or disassembled unless you know what you're doing. Please ask us about this questioning.

Danger

Attention! Never work on electrical connections when the machine is switched on.

3 Part name

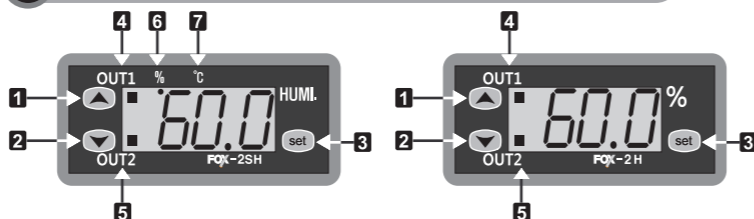

- 1 Setting up(UP)
- 2 Setting down(DN)
- 3 setting switch(SET)
- 4 Main output
- 5 Auxiliary output
- 6 Humidity display(FOX-2SH(R))
- 7 Temperature display(FOX-2SH(R))

FOX-2SH(R) : humidity display and control + temperature display for the currency status display, there're 2 kinds of mode, as a switch of <UP(increase), DN(decrease)>, you can change the display like "Humidity/ Temperature".
FOX-2H, FOX-2H-2 : humidity display and control

4 Connection

< FOX-2SH / FOX-2SHR >

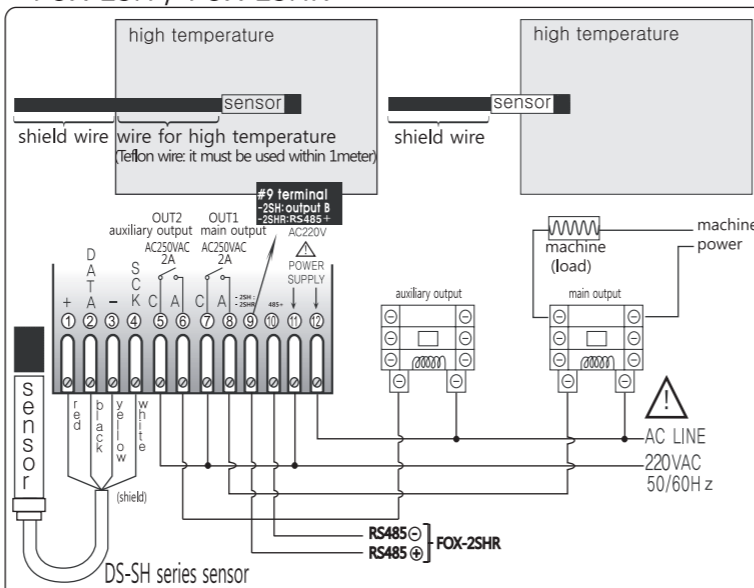

Ref1. Detailed specifications for the applicable sensor specifications, see the back of the '10. sensor's specifications'.
Caution1. Please make use of the shield wire when lengthening of the sensor wire, and in case of using in the high temperature range of 65℃~80℃, surely use the high temperature using wire(Teflon wiring).
Caution2. Please make the operating machine(load) be driven with using the power relay or magnet outside surely because its output specification of inside relay is less than 250VAC 2A.

< FOX-2H, FOX-2H-2 >

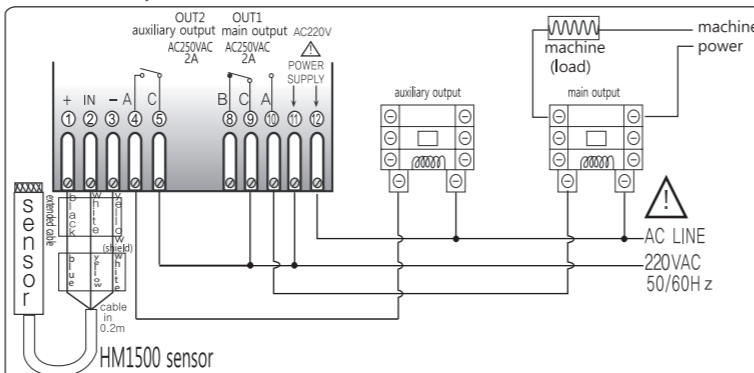

Ref1. Detailed specifications for the applicable sensor specifications, see the back of the '10. sensor's specifications'.
Caution2. Please make the operating machine(load) be driven with using the power relay or magnet outside surely because its output specification of inside relay is less than 250VAC 2A.

5 Setting for programs

User setting humidity



Program setting

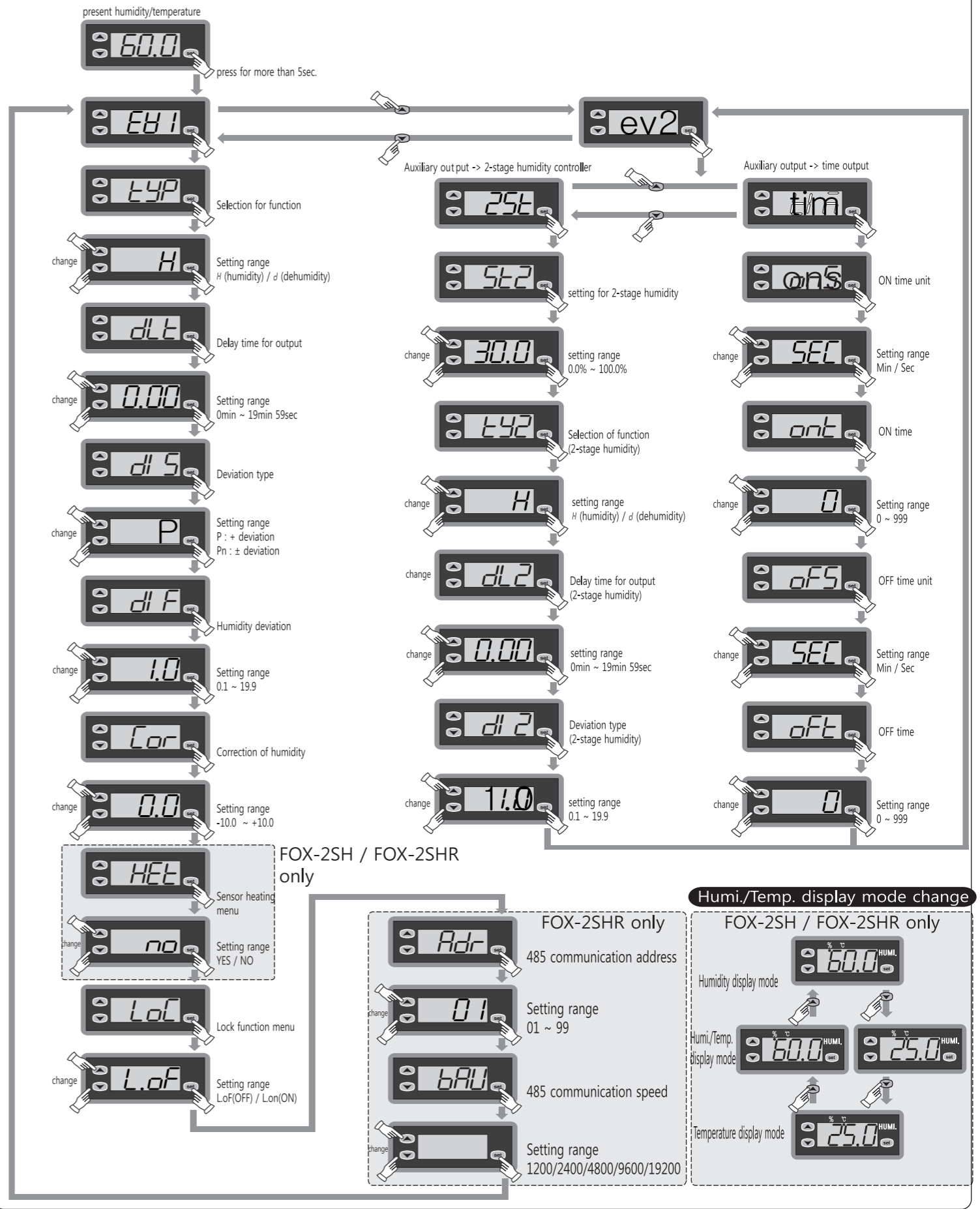

Humi./Temp. display mode change

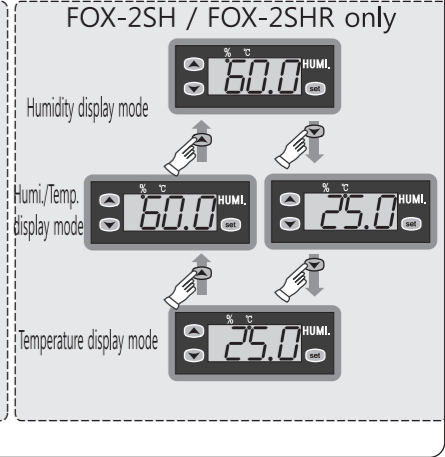

7 Detailed explanation

1 EHI Set value of the main output

2 EYP Selection for function

H : humidity d : dehumidity

3 dLT Delay time of the output

- It is widely used as the followings

- in case of operating the ON/OFF control very often
- to protect the operation machinery when re-input of the power supply or momentary stoppage of power supply

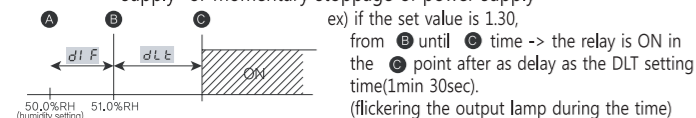

4 dLS Selection of the deviation for a main output

P : + deviation Pn : ± deviation

5 dLF Setting for temperature deviation

In the ON/OFF control, it needs at regular interval between ON and OFF. By operating the ON/OFF control frequently, the relay or its output contact can be damaged quickly and it also occurs the hunting(oscillating, chattering) by virtue of external noise. You can make use of the temperature deviation in order to protect its relay or contact and so on.

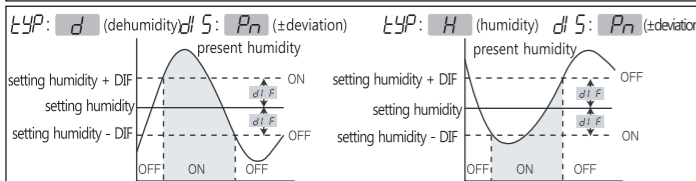
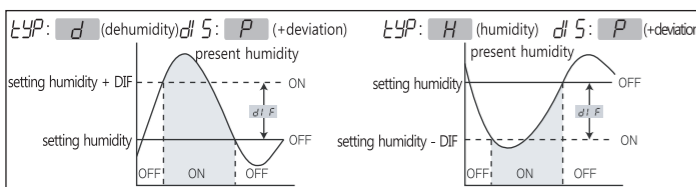

6 LOR Correction of the present humidity

Correction function for a discrepancy between the present's display value and the actual value(accurate value)

ex) An actual humidity value is 55.5%RH only, but the present humidity's display value was 57.5%RH
=> You may use this function and can correct the display's humidity value by -2.0%RH

Caution. Actual humidity is validated the performance and accurately calibrated by using the equipment to produce. If an inaccurate equipment calculated on the basis of the actual humidity calibration, it can be caused problems with product operation.

7 HEE Heating element for humidity sensor (only FOX-2SH)

It is possible to be covered with dew when the humidity is high, If the present humidity is 95%RH, it is generated heat inner its sensor in order to prevention of dewy.

YES It is operated the heating function automatically if the humidity is more than 95%RH. It is removed it if the humidity is less than 95%RH

no The heating function will be prohibited.

Caution-It must be set up "NO" because the heating function can not be used for more than 95%RH

* R.F) The present temperature's display can be increased a little while operating of the humidity sensor's heating function

8 Lof Lock function of setting data

As a safety device, it is used in orser not to change the set value except for an main user

L.on Setting for lock function **L.of** removal for lock function

9 Adr RS485-communication address setting

The product FOX-2SHR supports RS485 communications. when communicating with the master device for mutual recognition is the ability to set the communication address.

10 bAU RS485-communication speed setting

when communicating with the master device to the exchange of accurate data must match the communication speed.

11 EHZ Set values for an auxiliary

12 ZSE auxiliary output -> 2-stage output

13 SEZ change of the setting humidity for an auxiliary output

14 EYZ Output type for an auxiliary output

H : humidity d : dehumidity

15 dLZ Delay time of the auxiliary output

see the 3. dLT menu

16 dLZ Humidity deviation of the auxiliary output

see the 5. dLF menu

17 ELn auxiliary output -> time output

18 onS auxiliary output on time
n : setting for a minute unit SEC : setting for a second unit

19 onT auxiliary output -> on time

20 ofS auxiliary output off time

n : setting for a minute unit SEC : setting for a second unit

21 ofT auxiliary output -> off time

8 Size & dimension

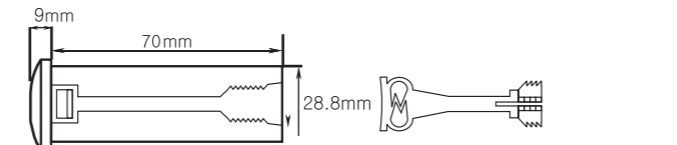
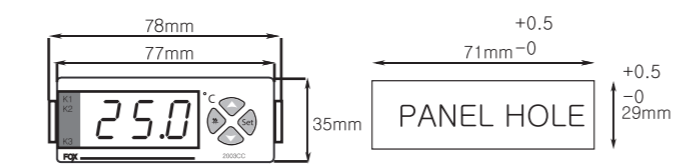
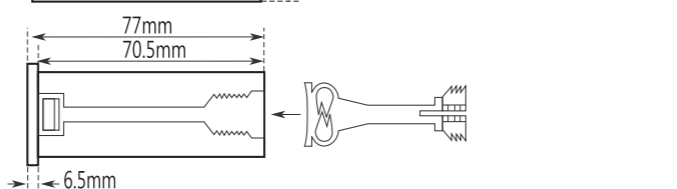
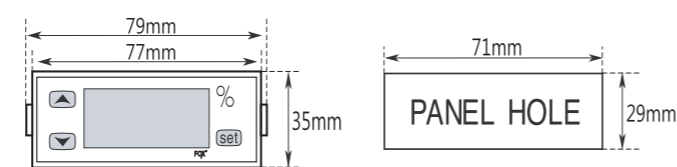

9 Setting range & Set value when deliver

Model	Division	Function	Range	set value when deliver
FOX-2SHR	Main output	SEZ	setting for humidity	0.0~100.0%Rh 30.0%Rh
		EYP	selection for function	H / d H(humidity)
		dLT	delay time for output	0.0~19min 59sec 0min 0sec
		dLF	humidity deviation	0.1 ~ 19.9 0.1
	Sensor	dLS	deviation type	P / Pn P(+deviation)
		LOR	lock function	L.on/L.of L.of
	auxiliary output (2-stage)	SEZ	setting humidity	0.0~100.0%Rh 30.0%Rh
		EYZ	selection for function	H / d H(humidity)
		dLZ	delay time for output	0.0~19min 59sec 0min 0sec
		dLZ	humidity deviation	0.1 ~ 19.9 0.1
onS		ON time unit	n / SEC SEC (sec)	
ofS		setting for OFF time unit	n / SEC SEC (sec)	
Sensor	HEE	heating function for the humidity sensor	YES / no no	
	Adr	485 communication address	01 ~ 99 01	
communication	bAU	485 communication speed	120	(1200Bps)
			240	(2400Bps)
			480	(4800Bps)
			960	(9600Bps)
			1920	(19200Bps)

10 Sensor's specifications

< DS-SH series > FOX-2SH FOX-2SHR

Model : DS-SH[A][H]	
A(Humidity Accuracy)	H(Housing Type)
- 0 : ±4.5%	- 04 : Stainless Body Length 40mm(To the ambient temperature is 80°C)
- 1 : ±3.0%	- 12 : Stainless Body Length 120mm(To the ambient temperature is 80°C)
- 5 : ±2.0%	- 220 : Plastic Case

Caution1. When using a communication shield wire, the distance sensor installation is within 20m.

Caution2. In addition to using the shield, when using a wire, the distance sensor installation is within 3m.

Caution3. Installation direction refers to the shown below.

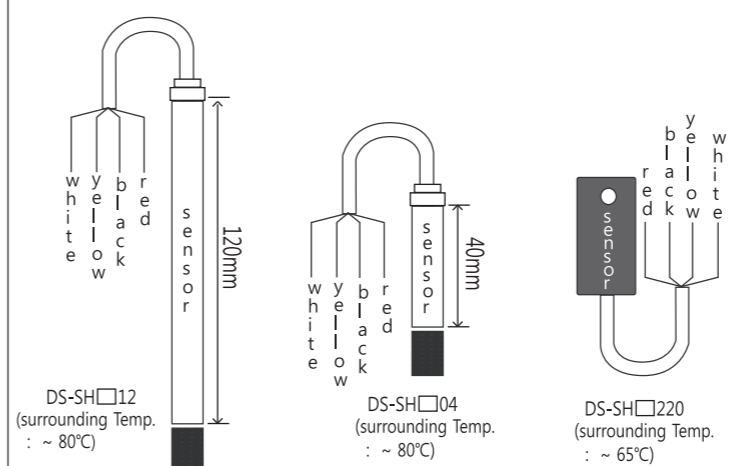

< HM1500 > FOX-2H, FOX-2H-2

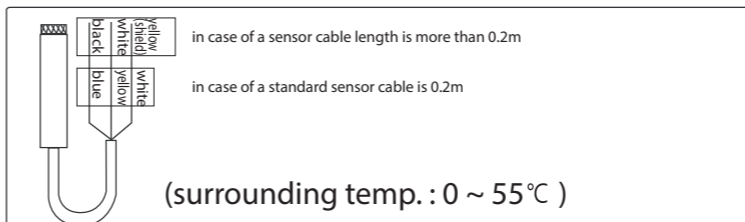

11 Communication interface (FOX - 2SHR)

specification	in conformity EIA RS485
The method of communication	two wire half-duplex operation
synchronous system	asynchronous system
communication distance	within 1.2Km
communication speed	1200/2400/4800/9600/19200bps
StartBit	fixed 1bit
StopBit	fixed 1bit
ParityBit	none
DataBit	fixed 8bit
Protocol	BCC

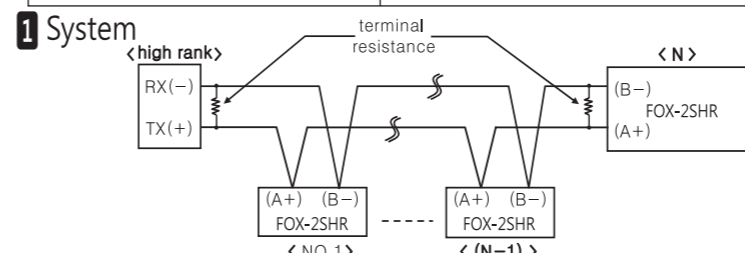

2 Definition between communication command and block

< Show the format of the command >

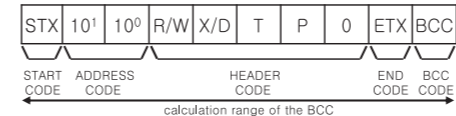

< Show the format of the response >

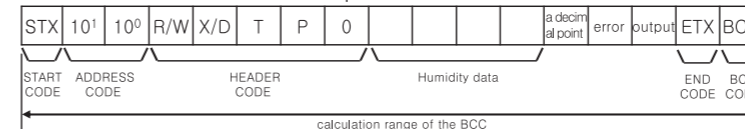

① START CODE

Show the lead(head) of the block
STX -> [02H]

② ADDRESS CODE

A high rank system can discriminates the channel code number among FOX-2SHR. It is available to set between 01 and 99(BCD ASCII)

③ HEADER CODE

Show the command name as an alphabetic letter
RX(reading demand)-> R[52H], X[58H]
RD(reading response)-> R[52H], D[44H]
WX(writing demand)-> W[57H], X[58H]
WD(writing response)-> W[57H], D[44H]
TPQ(temperature measuring value)-> T[54H], P[50H], O[30H]

④ Composition of data

Data is displayed as "Hexa decimal"
(negative number : 2's complement)

⑤ Decimal point

0[30H] there is no "decimal point"
1[31H] there is "decimal point"

⑥ Error

0[30H]: there is no "error"
1[31H]: interrupted of the sensor' s cable
2[32H]: low error
3[33H]: high error

⑦ Output

output	auxiliary time output	2-stage output	main output	output	auxiliary time output	2-stage output	main output
0x30	OFF	OFF	OFF	0x34	ON	OFF	OFF
0x31	OFF	OFF	ON	0x35	ON	OFF	ON
0x32	OFF	ON	OFF	0x36	ON	ON	OFF
0x33	OFF	ON	ON	0x37	ON	ON	ON

⑧ END CODE

show the end(close) of the block ETX -> [03H]

⑨ BCC(Black Check Character)

Show the XOR arithmetic and logic values from the start(STX) to the ETX

- the others : As of no response of the ACK
- ① in case of not equivalent to the channel after receiving STX
- ② in case of generating the receive buffer overflow
- ③ in case of not equivalent to the communication' s set values or baud rate
- treatment : in case of no response of the ACK
- ① check the cable
- ② check the communication' s condition(set values)
- ③ if the main cause of the status is the noise, try to do communication practicing 3times until recovering nomally
- ④ change the communication speed in case of bring about the communication's error frequently

12 Error message

- **E-1** - Memory error. Turn the power off and turn it on again. If the error message persists, please request us A/S by return.
- **O-E** - Sensor error. The sensor is interrupted. Check the cable.
- **S-E** - Sensor error. The sensor is short-circuited. Check the cable.

* The product's specification can be changed without any notification to improve its quality.

■ **H.Office** : Ballyonsandan 1-ro, Jangan-eup, Gijang, Busan, Republic of Korea

■ **Factory** : Ballyonsandan 1-ro, Jangan-eup, Gijang, Busan, Republic of Korea

■ **A/S** TEL : 051 - 819 - 0425 ~ 7

■ **e-mail** : condec@condec.co.kr
URL : www.condec.co.kr

■ This device works proper operation with;
surrounding Temp. : 0°C ~ 60°C
surrounding Humi. : below 80%RH
Regular : 220Vac ±10% 50/60Hz

■ **Main products & Development**
- Digital temperature/humidity controller
- Digital timer, Current/voltage meter
- The other development products