

Manual

DSFOX - SL30



- A user manual for this product is posted on the company website.
- Please download the technical document and communications manual on the company website.

www.conotec.co.kr

1 Safety precautions

Please read the safety precautions carefully for correct operation of the product.
 ※ The specifications and dimensions specified in this instruction manual may be changed without any notice for performance enhancement.

Warning

1. This product was not made as a safe device. Therefore, this product should be attached with dual safety devices if it is used for the control purposes (e.g. a device vulnerable to accident and property damage, etc.).
2. Do not wire, inspect or service this product while the power is being supplied.
3. You must attach this product to a panel. Otherwise, it may cause an electric shock.
4. When connecting the power, you must check the terminal number.
5. Do not ever disassemble, process, modify or repair this product.

Caution

1. Please make yourself familiar with all the operation instructions, safety precautions and warnings before using this product. Comply with related specifications and capacity requirements
2. Do not wire or install this product to any unit with high inductive load (e.g. motor, solenoid, etc.).
3. Use a shielded cable with a proper length when extending a sensor.
4. Do not use any part that generates an arc when used in the same power or directly switched in close proximity.
5. Keep the power cable away from a high-voltage cable and do not install this product in any place that is full of water, oil and dust.
6. Do not install this product in any place that is exposed to direct sunlight or rain.
7. Do not install this product in any place that is subject to strong magnetic power, noise, vibration or shock.
8. Keep this product away from any place that generates strong alkaline or acid substances. Use a separate pipe.
9. Do not sprinkle water onto this product for cleaning when installing it in the kitchen.
10. Do not install this product in any place where the temperature/humidity ratings are exceeded
11. The sensor cable should not be cut or cracked.
12. Keep the sensor cable away from a signal cable, a power cable or a load cable. Use a separate pipe.
13. Keep in mind that the follow-up service will not be available if this product has been arbitrarily disassembled and modified
14. ⚠ symbol on the terminal wiring diagram indicates a safety statement that alerts a warning or caution.
15. Do not use this product near any device generating strong high-frequency noise (e.g. high-frequency welding machine high-frequency sewing machine, high-frequency radio, large-capacity SCR controller, etc.).
16. Using this product in any method other than those specified by the manufacturer may lead an injury or a property damage

17. This product is not a toy. Keep it away from children
18. This product should be installed only by an expert or a qualified person.
19. The company will not be liable for any damage caused by the violation of the above warnings and cautions or by a consumer's fault

Danger

Caution: Risk of electric shock

- Electric shock - Do not touch the AC terminal while the current is flowing. It may cause an electric shock.
- You must disconnect the input power when servicing it.

2 Model types

Model	Sensor	Control Type	Temperature Range	Power	Function
DSFOX-SL30 (for freezing)	NTC 10K	Relay contact (3EA)	Cel: -55.0 °C sius: ~ +99.9 °C Fahren: -60 °F heit: ~ +200 °F	100~240 VAC 50/60Hz	Comp control Defrosting control Evaporator fan control

3 Components

Product appearance and components



- | | | |
|-----------------------|-----------------------------|---|
| 1 Comp output display | 2 Defrosting output display | 3 Fan output display |
| 4 SET switch | 5 Defrost & Back switch | 6 Up switch |
| 7 Down switch | 8 Temperature unit | 9 Low-temperature prevention output display |

4 Terminal wiring diagram

[DSFOX - SL30]

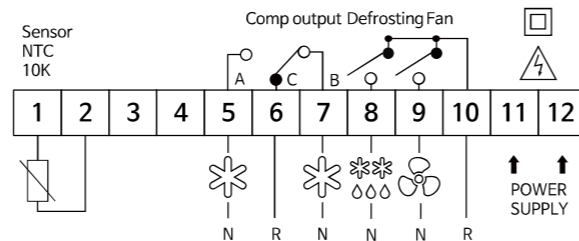

- ※ Output: 250VAC 2A; A power relay or a magnet must be used.
- ※ Be careful that any load over the contact capacity may cause contact fusion, contact defect, relay damage or others.

5 Setting process

Setting method

Name	Image	Description
SET key	SET	Entry into or return to the settings page Selection and saving of data values
Defrost & Back key	●	Manual defrosting ON/OFF Go to the previous menu when setting up a program
Up/down key	▲ / ▼	Increment/decrement of the selected menu data

Change of the temperature output's set temperature (temperature setting)

- 1) If you press the SET key once, the setting will blink and be displayed
- 2) Increase or decrease the setting with the ▲ or ▼ key.

Installer mode settings (Program setting)

- 1) Press the SET key for at least 5 seconds to enter into the installer mode.
- 2) Configure the program based on the temperature program configuration diagram.

Manual defrosting and defrosting stoppage

- 1) In the freezing mode: Manual defrosting will commence if you press the ● key for at least 3 seconds.
- 2) In the defrosting mode: Defrosting will stop if you press the ● key for at least 3 seconds.

Temperature setting

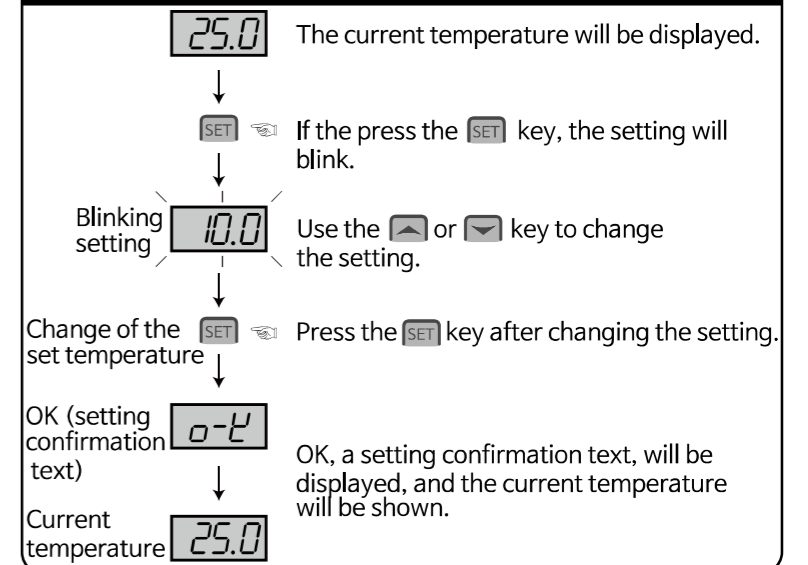

Program setting

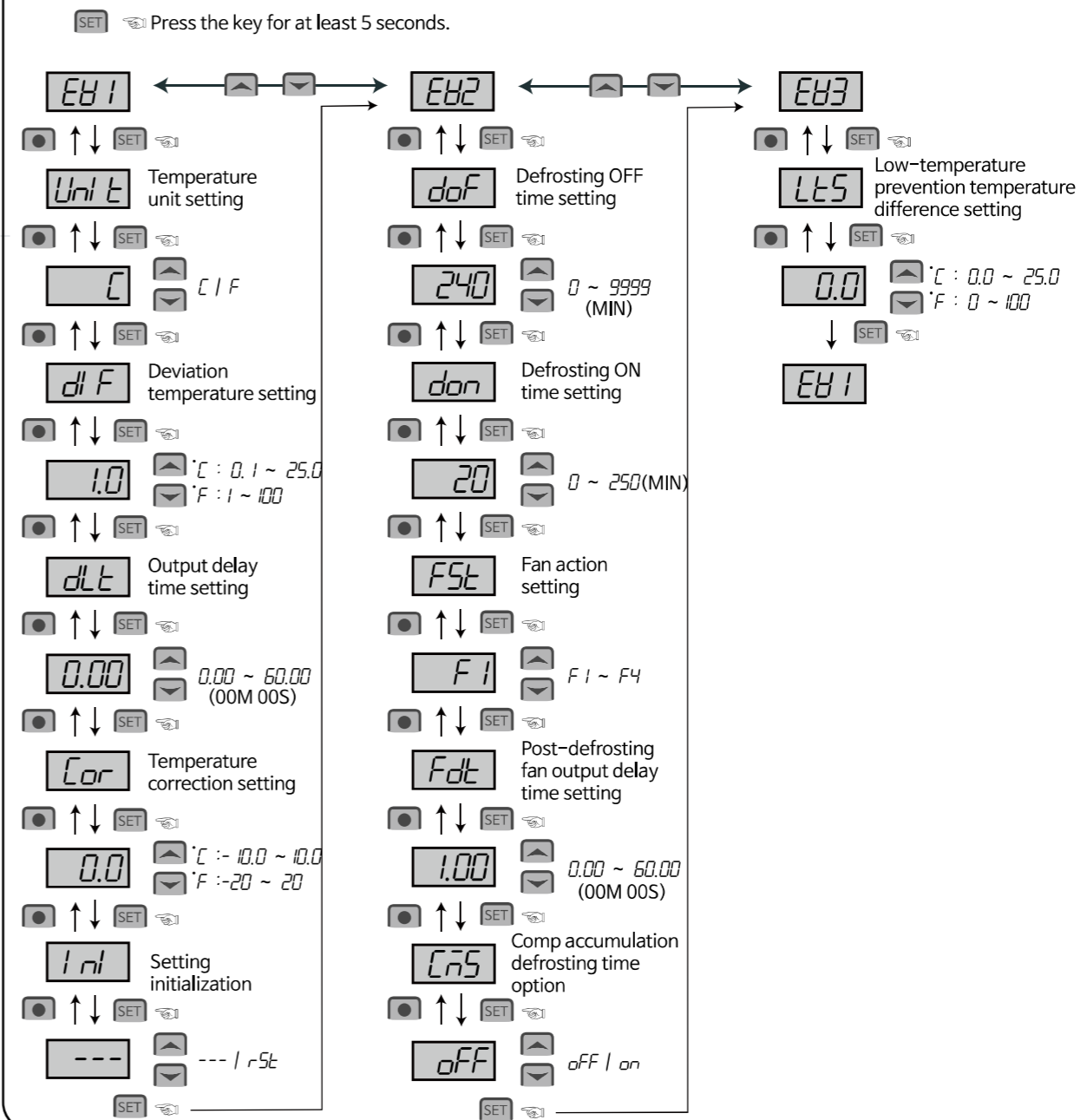

6 Function details

Eh1 : Modification of various settings for temperature output, communications and others

Eh2 : Modification of various settings for defrosting and fan output

Eh3 : Modification of various settings for alarm

Unit : Change of the temperature unit

- C (temperature displayed in Celsius)
- F (temperature displayed in Fahrenheit)

※ Note: If you change the **Unit** while the product is running, all the settings except for the unit will be initialized to factory settings. Please reset all the settings.

dIF : Deviation temperature setting

- For on/off control, there should be a certain interval between on and off.
- A relay or other output contacts may be quickly damaged or experience hunting (electricity generation, chattering, etc.) due to an external noise if the on/off function is used too frequently.
- Different temperature is set to prevent such phenomenon and protect relevant contacts.
- Example 1) Set temperature: 10.0°C, **dIF** : 5.0

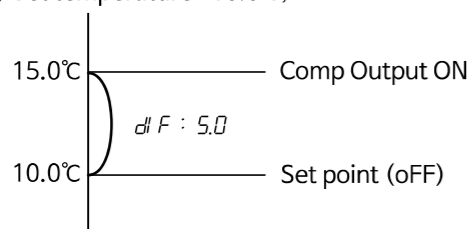

dLT : Comp delay time setting

- Used if the on/off function of a control target is used too frequently (freezer, compressor, etc.)
- Protects running machine from momentary outage or power re-connection

e.g.) When is the output on for the following conditions: set temperature (10.0°C); **dLT** (00.30), **dIF** (5.0°C)?

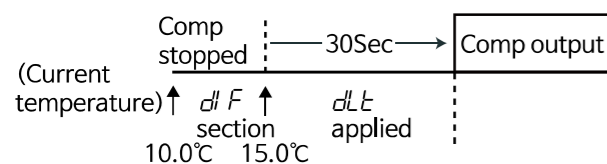

Cor : Correction of the current temperature

- Used to correct the current temperature based on the reference temperature (e.g. mercury thermometer, existing thermometer, thermostat, etc.) when there is an input error by an external sensor even though the product itself does not have any problem

e.g.) Actual temperature: 10.0°C

Display window: 12.0°C → **Cor** Modification of 0.0 to -2.0 → Displayed as 10.0 (current temperature modified)

Ini : Setting initialization

- If set at **5-E**: The current temperature will be displayed after the product's model name is displayed.
- ※ Note: All the settings will be initialized to factory settings. Please verify them.

△ Note : When you arbitrarily run a defrosting machine, consider the machine's condition and be alert for a fire.

doF : Defrosting OFF time (defrosting cycle)

- Setting range: 0 ~ 9999 minutes
- Defrosting will proceed after the set time elapses.

don : Defrosting ON time

- Setting range: 0 ~ 250 minutes
- Defrosting will commence when the defrosting cycle comes

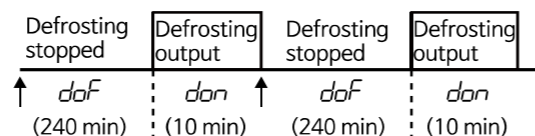

- Defrosting will be repeated for 10 minutes every 240 minutes

※ Note: If 'don' = 0, defrosting will be prohibited.

■ Setting the manual defrosting

1. Manual defrosting ON: If you press the **SET** key for at least 3 seconds, manual defrosting will commence as the defrosting LED lights. 'n.on' and the remaining defrosting time will be displayed alternately on the display.
2. Manual defrosting OFF: If you press the **SET** key for 3 seconds while manual defrosting is set ON, it will be OFF. Otherwise, it will be automatically stopped in 'don' hours.

FSE : Fan action setting (F1 ~ F4); See the program configuration diagram.

■ Fan setting chart

		When comp is on	When comp is off	When defrosting is on
Fan setting	F1	FAN ON	FAN OFF	
	F2	FAN ON		
	F3	FAN ON	FAN OFF	FAN ON
	F4	FAN ON		FAN OFF

Fdt : Post-defrosting fan output delay time setting

- Setting range: 0.00 ~ 60.00 (minute.second)
- The delay time will become effective from the time when defrosting is over regardless of the comp output.
- e.g.) **Fdt** : 01.00 (1 minute)

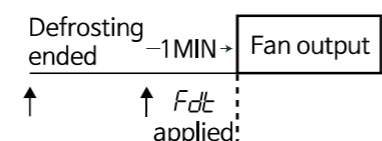

CRS : Comp accumulation defrosting time option

- If set at on: Defrosting operation based on the comp accumulation
- If set at off: Defrosting operation based on the cycle
- ※ If the comp accumulation time is greater than doF (defrosting OFF time), defrosting will commence.

LtS : Low-temperature prevention temperature difference setting

- If **LtS** is 0, the low temperature prevention function will be off.
- Current temperature ≤ (set temperature - **LtS**) → Defrosting/fan ON
- (When running in the **LtS** mode, defrosting/fan will be instantly output regardless of the fan setting chart)

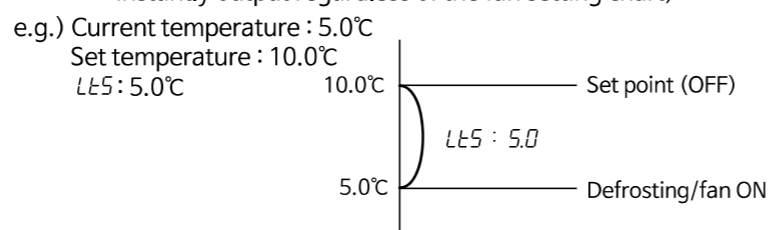

7 Setting range and factory settings

Display	Function	Applicable range in Celsius	Applicable range in Fahrenheit	Factory setting	Remarks
	Temperature setting	-55.0 ~ 99.9	-60 ~ 200	10.0	
Unit	Temperature unit	C / F		C	C : Celsius F : Fahrenheit
dIF	Deviation temperature setting	0.1 ~ 25.0	1 ~ 100	1.0	
dLT	Output delay time setting	0.00 ~ 60.00		0.00	minutes, seconds
Cor	Temperature correction setting	-10.0 ~ 10.0	-20 ~ 20	0.0	Correction of the difference between the displayed temperature & actual temperature
Ini	Setting initialization	---		---	
doF	Defrosting OFF time	0 ~ 9999		240	Minutes
don	Defrosting ON time	0 ~ 250		20	Minutes
FSE	Fan setting	F1 ~ F4		F1	look at the chart
Fdt	Post-defrosting fan output delay time	0.00 ~ 60.00		1.00	Minutes, seconds
CRS	Comp accumulation defrosting time option	on / off		off	
LtS	Low-temperature prevention temperature difference setting	0.0 ~ 25.0	0 ~ 100	0.0	

9 Product dimensions and panel processing dimensions

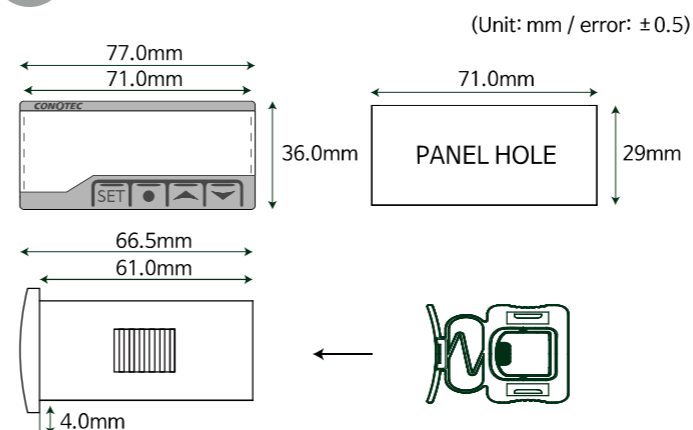

10 Easy error diagnosis instructions

※ If an error is displayed while the product is running

- **Eri** : It is a case where the product was subject to a strong external noise and internal data memories have been damaged. In this case, contact us for product service.
- Although this controller was designed to withstand a certain level of external noise, it is not supposed to withstand all levels of noise.
- If the product is subject to a noise greater than 2KV, it could be internally damaged.
- If **o-E** (open error) or **s-E** (short error) is displayed, there is something wrong with a sensor. Please check the sensor.
- If **n.on** (defrosting ON) is displayed, the product is in the defrosting mode.
- A text such as **LoCL** (lock) indicates that the product is in the lock mode.
- If **o-E** (OK) is displayed, settings have been saved.
- If **SL30** (product name) is displayed, it refers to a model name.

MEMO

※ The above specifications may be changed without any notice for performance enhancement. Please make yourself fully familiar with and follow the above precautions.

■ Address: (Street address) 56, Ballyongsandan 1-ro, Jangan-eup, Gijang-gun, Busan, ROK
(Land-lot address) 901-1, Ballyong-ri, Jangan-eup, Gijang-gun, Busan, ROK (46034)

• Product service : 070-7815-8266
• Customer service: 051-819-0425 ~ 0427
• FAX : 051-819-4562 • Website : www.conotec.co.kr
• Email : conotec@conotec.co.kr
• SNS : Facebook, Instagram, Twitter, YouTube Search for 'Conotec'

◆ Installation precautions

- This device should be connected to a protective earth terminal and a power supply in order to prevent an electric shock.
- Do not block the air outlet.

◆ Operation precautions

- ※ An operating environment of this device is as follows.
 - Ambient temperature: 0 ~ 60°C
 - Ambient humidity: 80% RH or less
 - Indoor uses only
 - Pollution class: 2
 - Altitude under 2000m
 - Installation category: II
- This device should be laid out in a way that its power cord is easy to handle
- Using this product in any method other than those specified by the manufacturer may damage its protection function

■ Major products and development

- Temperature/humidity controller
- Counter and timer controller
- Current and voltage panel meter
- Temperature/humidity indicator
- Oven controller
- CO2 controller
- PID controller
- Unit cooler controller
- Heat pump controller
- Chiller controller
- Thermo-hygrostat controller
- Short message alarm
- Temperature/humidity transmitter
- Smartphone app and monitoring system

※ This manual was prepared in the Naver Nanum fonts.